

BEGA

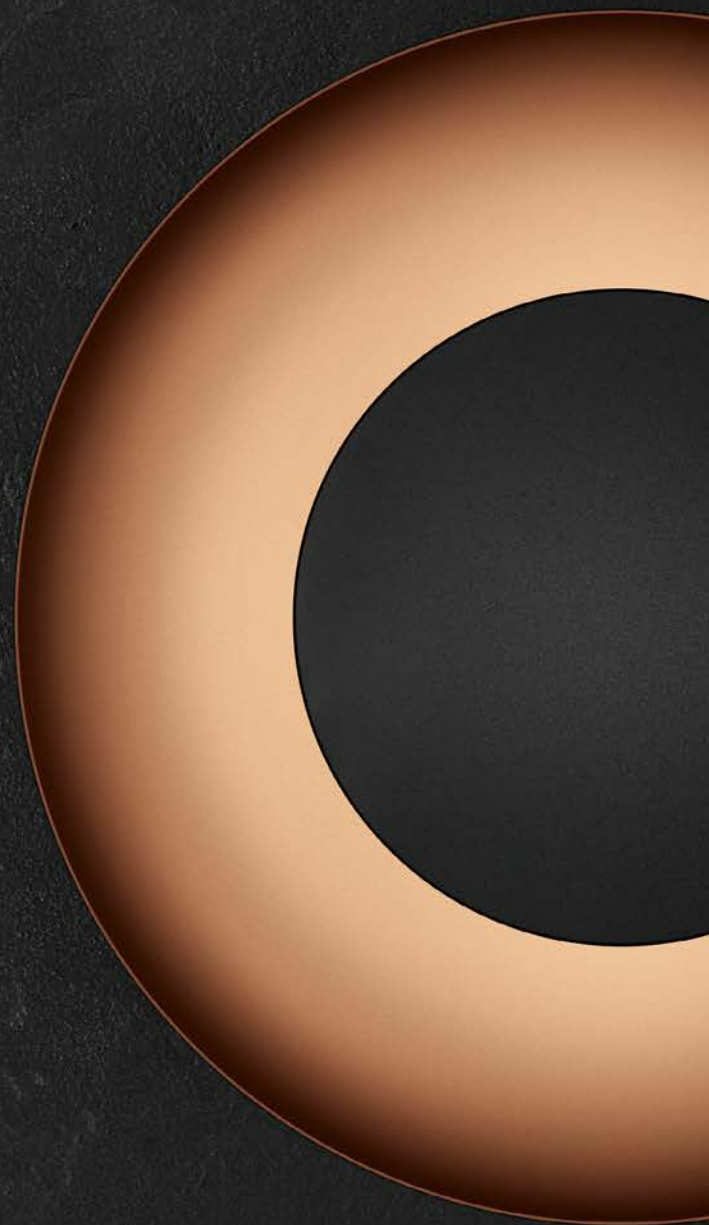

BEGA

Das gute Licht.

Recessed ceiling luminaires

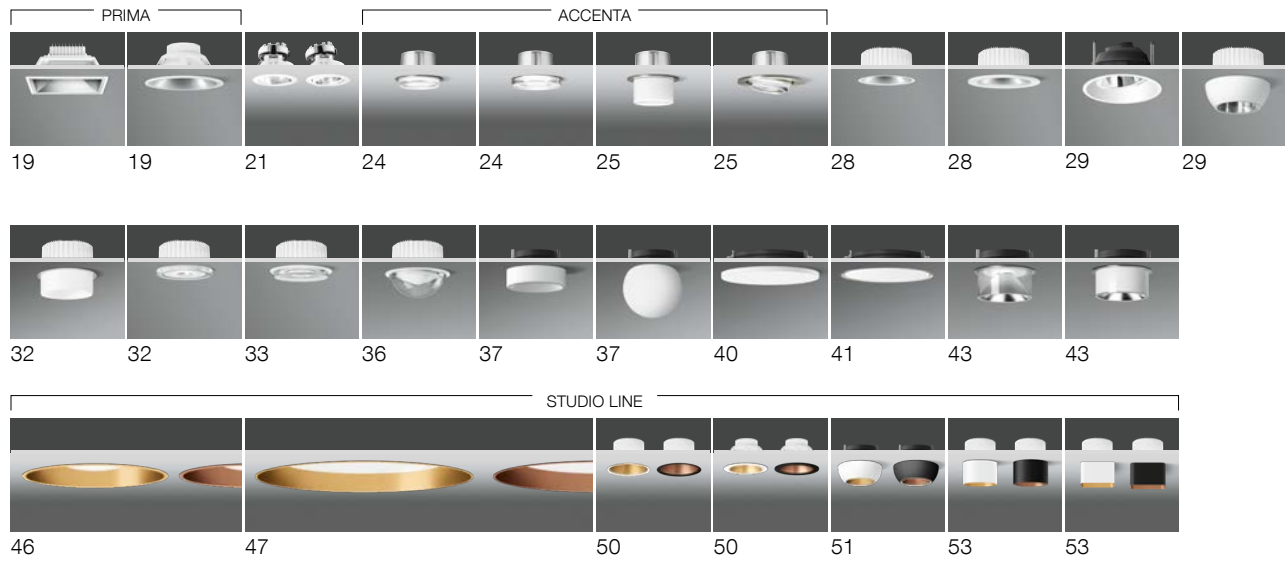

Ceiling luminaires

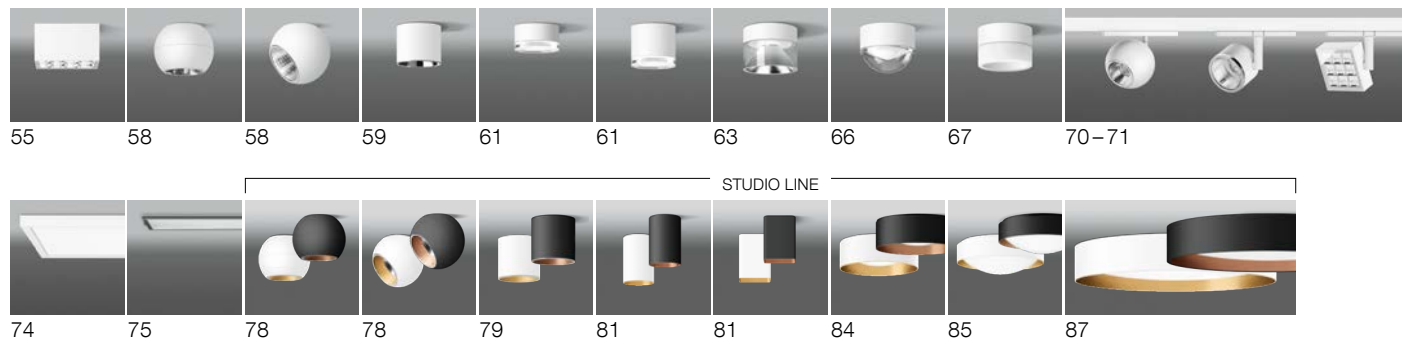

Ceiling and wall luminaires

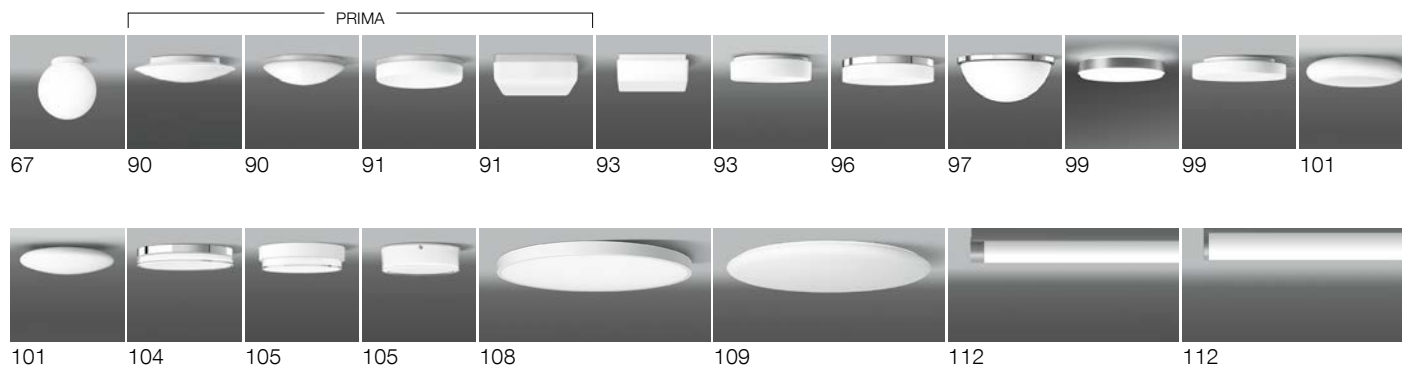

Recessed wall luminaires



Wall luminaires



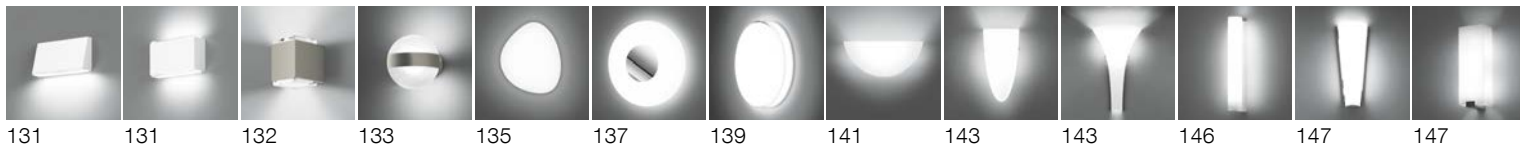

Wall luminaires

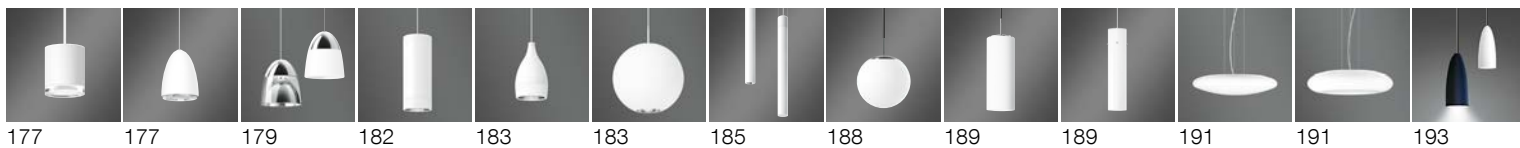
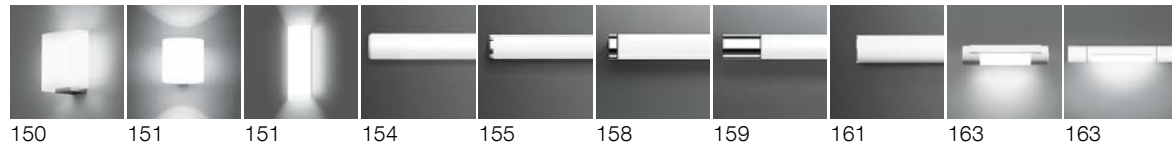

Pendant luminaires

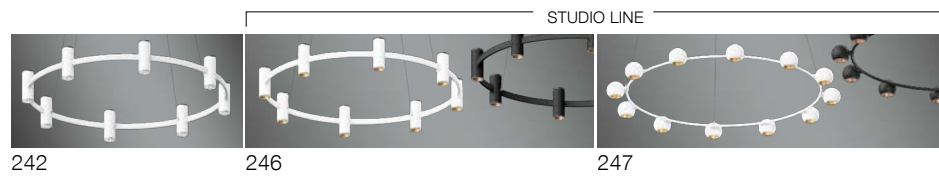
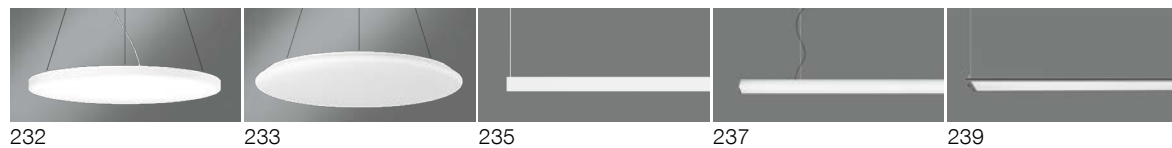

Table and floor luminaires

BEGA



About us and our luminaires

BEGA has been developing and producing high-quality luminaires for virtually all areas of interior and exterior architecture for more than 75 years. These years have given rise to products whose ideas and trademarks have become generic terms for countless luminaires in the entire industry.

For many years, glass created a fascination and drove the development of indoor luminaires in general. We are still very proud of the fact that we can rely on our own glass manufacture.

Today, we complement the traditional with translucent luminaire elements made from a variety of materials. As always, light transmission and directing features remain at the forefront of our developments.

LED technology has given us virtually endless room for new designs. It has become another area in which we were able to create the required independence for our work at the highest level in our own module production.

In our development process, our main focus has always been on our products retaining their value for a long time to come. That is how we have been able to save valuable resources with our responsible and intelligent use of raw materials. The terms durability and sustainability have been and will always be part of our company ethos.

As structural details, our luminaires are closely bound to architecture. They are designed to be professional lighting tools for effective indoor and outdoor illumination.

Our goal is to create durable assets that are designed to stand the test of time for decades to come.

About this catalogue

This catalogue contains our current indoor luminaire range. In addition to the product illustrations and inspiring pictures of applications, we also offer an overview of the technical data for each luminaire at the time of print.

Some products experience technical changes due to our ongoing improvement process. We have marked all products with a small magnifying glass and a reference number for you to look up latest technical data at any time.

Simply enter that number in the search field on our website bega.com to find all the product information you need. Here you will also find detailed information about the relevant surface colour of the luminaires. On the actual product pages, we only provide a coloured square to denote the available colours for the various luminaires.

During the validity period of the catalogue (two years), we will be extend our range to include many more luminaires – all our new products will be published on our website at bega.com/indoor.

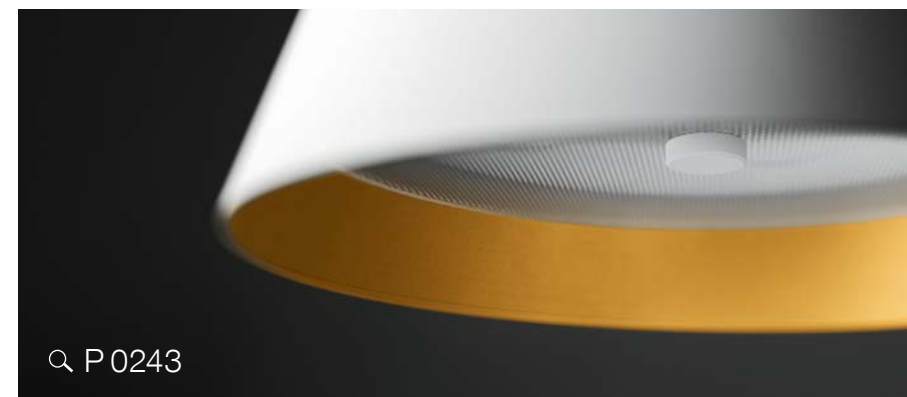

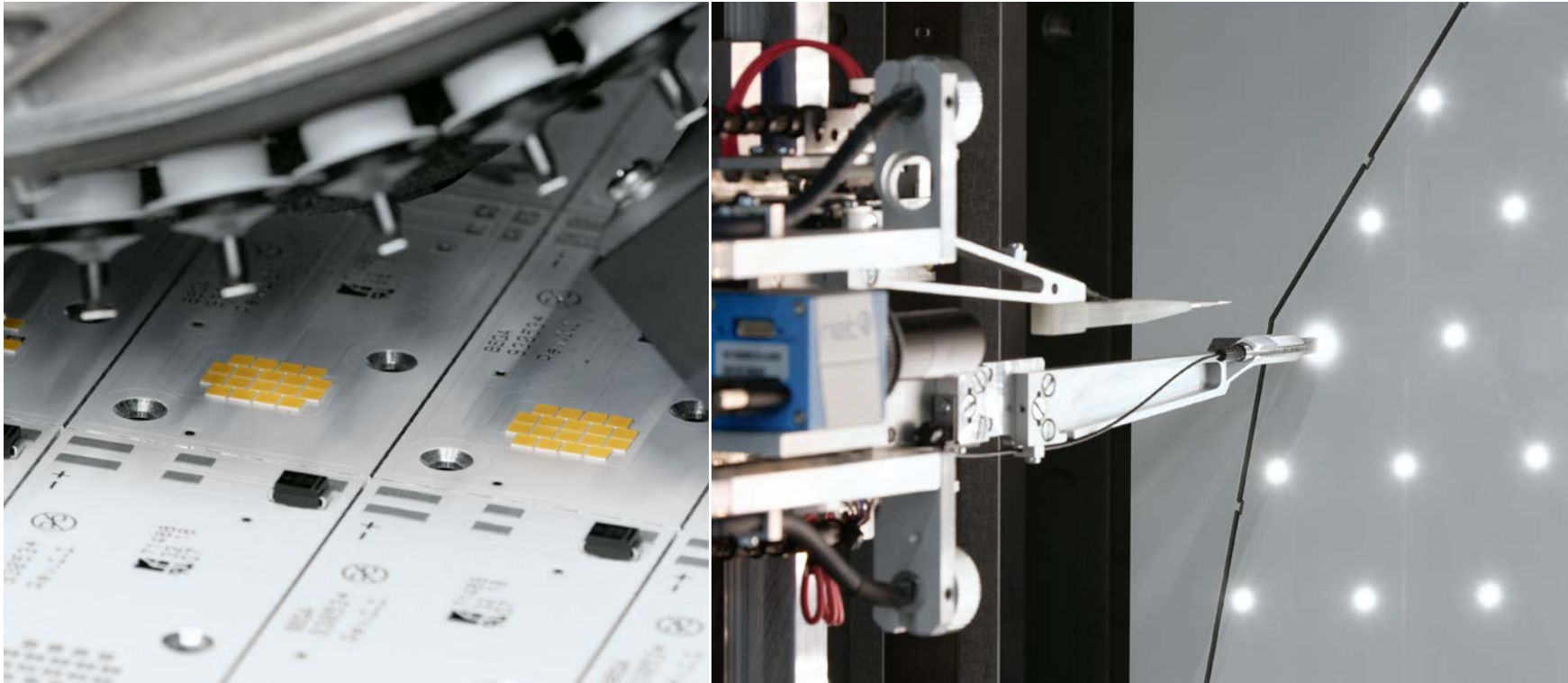

Our LED technology

Decades of experience have taught us the quality that is demanded of our luminaires. This knowledge has allowed us to consistently improve our products across the board. We recognised early on that our quality requirements for LED lighting and its components were not achievable with conventional parts readily available in the market. We therefore added our own state-of-the-art module production facilities at our locations to ensure we would have a maximum of freedom in terms of development and would be able to meet our own standards.

All BEGA LED luminaires are supplied with tailor-made modules from our own production line. We have full control over all materials used and never have to compromise. We determine all important factors like light output, light colour, and the thermal management of a luminaire ourselves, which allows us to impact directly on its quality.

The ageing of electronic components, and specifically that of LED, depends largely on the temperatures they will be exposed to during operation. The higher the component temperature, the shorter its expected service life. Here, we create favourable temperature conditions for all components using design measures and only the very best quality components, allowing us to achieve a significantly longer LED service life. Protective electronic devices inside the luminaire additionally counteract any possible overheating of component parts. We also consistently use high-end and durable materials like glass, silicone and aluminium to ensure the highest possible ageing resistance for the entire optical system.

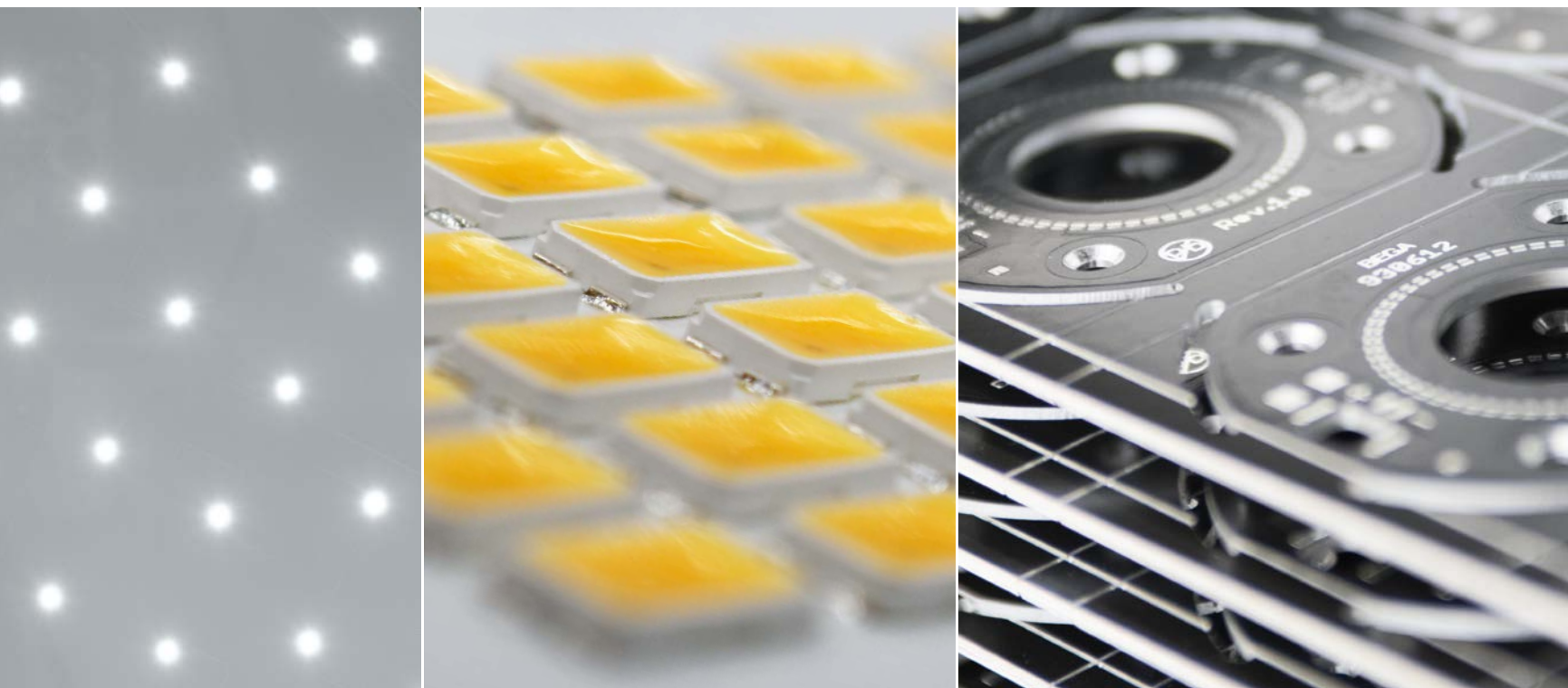

Replacement and 20-year availability guarantee

LEDs have a significantly longer service life than conventional lamps. Nevertheless, their lifespan is finite. What happens when an LED comes to the end of its service life? Who supplies a replacement for this electronic component – or will the luminaire or even the entire lighting system have to be replaced? Many manufacturers shy away from answering these questions. To date, we were unable to find answers from third-party module suppliers or various luminaire manufacturers that would satisfy our own understanding of business responsibility.

We were able to solve that issue for our customers by starting our own module production. A module identification number in each LED luminaire offers information about all installed modules. Our advantage is the fact that we manufacture everything ourselves: Based on that ID number, we can supply matching LED modules for many years to come.

We guarantee the availability of replacement modules as much as 20 years after an LED luminaire is purchased from us.

The technology and design of the components may have changed by then. But you can rest assured that the light colour and output of the replacements will match the LED modules originally installed.

Our LED luminaires are designed to allow these components to be replaced easily on site using standard tools. Suitable precautions have already been taken to protect against electrostatic discharge and accidental polarity reversal of the electronic components. The safe and economical further use of your LED luminaires is thus assured.

Our optical systems of the highest lighting quality

The longevity of BEGA products, premium quality and our sense of responsibility are just some of our guiding principles. Accordingly, the consistent use of the highest quality components forms part of our philosophy of sustainability.

The perfect interaction of our LED modules with precisely calculated and refined reflectors and optical lenses made of ultra-clear silicone allows us to optimise the efficiency of light deflection.

With our two trademarked technologies BEGA Hybrid Optics® and BEGA Vortex Optics®, we can rely on guaranteed durable, virtually wear-free optical systems of the highest quality.

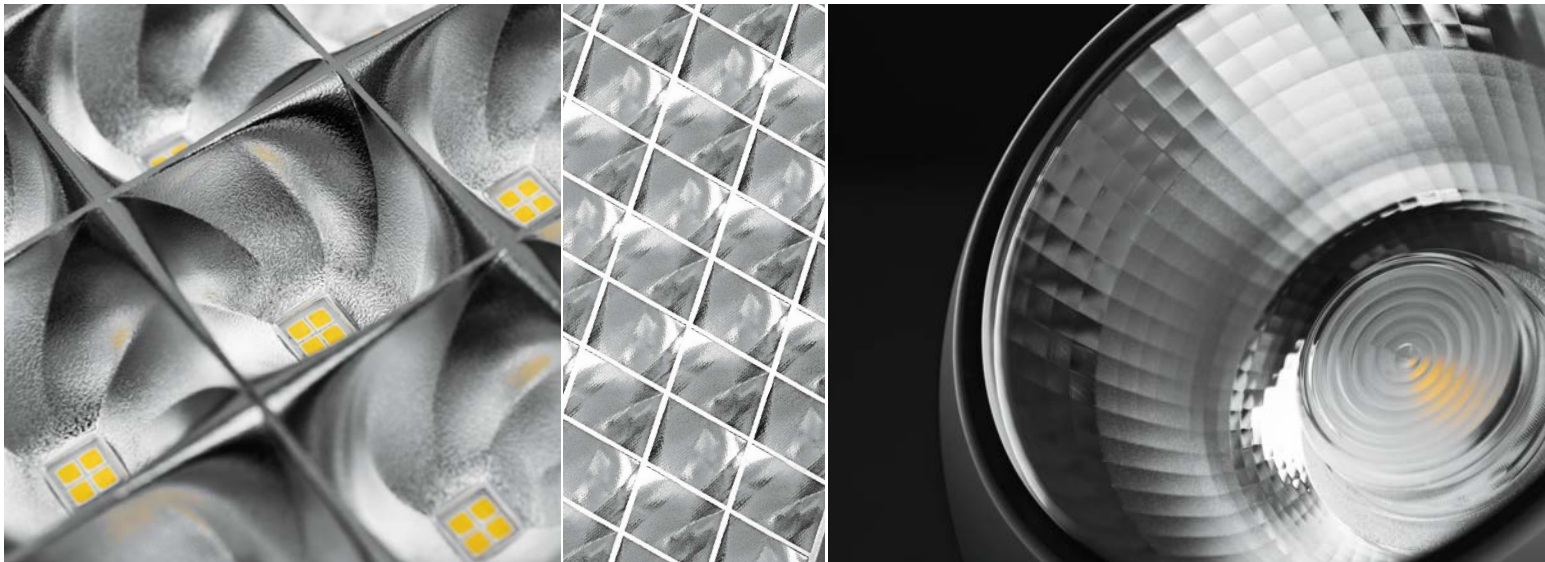

BEGA Vortex Optics®

BEGA Vortex Optics® features newly developed twisted reflectors with a pure aluminium finish. The more intense bundling of the light ensures perfect light deflection. This makes it possible to achieve optimal light distribution without artefacts. Thanks to excellent glare control, BEGA Vortex Optics® offers outstanding visual comfort. The interaction with the LED modules produces extraordinary lighting results.

BEGA Hybrid Optics®

BEGA Hybrid Optics® offers complete lighting control, thanks to optimum refraction and reflection. Precisely calculated reflectors with a pure aluminium surface and ultra-clear silicone or glass lenses capture virtually every beam of light from the LED modules. The interplay between lens and reflector technologies achieves maximum application efficiency.



Our technologies for protective thermal management and optimal component protection

Electronic components can be very temperature-sensitive and are often exposed to high temperatures inside a luminaire. Adverse ambient temperatures also place added strain on power supply units and modules in many places.

This can lead to malfunctions and damage to the components. BEGA Thermal Management® and BEGA Ultimate Driver® are protected trademarks. They guarantee thermal protective devices and power supply units of the highest quality.

BEGA Thermal Management® comprises two protection levels: BEGA Thermal Switch® and BEGA Thermal Control®. The protective device installed in each case depends on the luminaire type and its primary use. You can find data sheets for all luminaires on our website. These contain all luminaire data and the current values for LED service life, luminous flux, maximum ambient temperature, and they provide information on the BEGA Thermal Management® version.

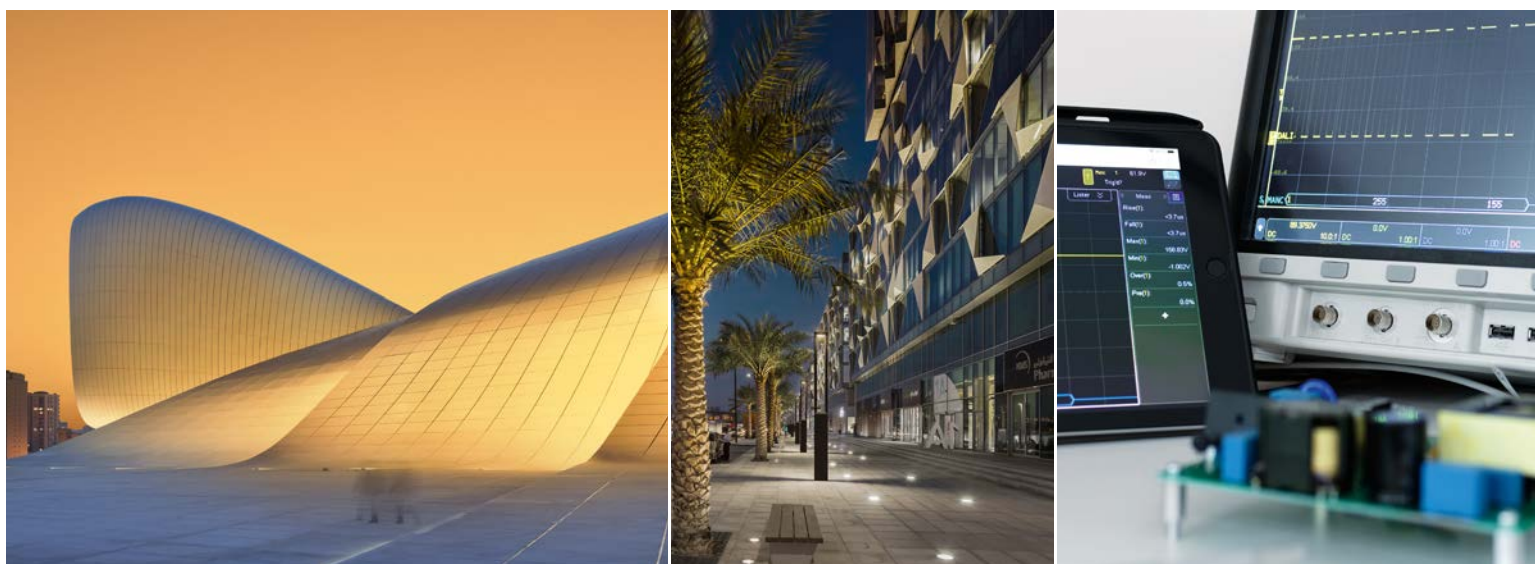

BEGA Thermal Switch®

Luminaires with the BEGA Thermal Switch® have a thermal cut-off that protects temperature-sensitive components by switching them off temporarily to prevent the luminaire from overheating in high ambient temperatures.

BEGA Thermal Control®

Luminaires with BEGA Thermal Control® come equipped with thermal regulation which temporarily controls the luminaire output for temperature-sensitive components or takes measures to regulate the temperature inside the luminaire to therefore protect the luminaire from overheating due to excessive ambient temperatures. The luminaires are not switched off, but continue to operate thanks to BEGA Thermal Control®.

BEGA Ultimate Driver®

BEGA Ultimate Driver® is a power supply unit developed according to the highest BEGA quality standards, and characterised by numerous unique features. These include: Optimal control with BEGA Thermal Management®, an impressive service life, high dielectric strength, maximum durability based on an extremely robust design, efficient overvoltage protection and a low inrush current.



The future is smart.
And when it comes to light: BEGA Smart.

Discover BEGA Smart – our holistic, intelligent control system. Our experts developed BEGA Smart specifically for daily use. We don't rely on gadgets or trends: Instead, we believe in sustainable improvements to quality of life in general.

The result is a sophisticated system that works in the background to make life easier – and which is delightfully easy to install and use. A system that encompasses many devices, functions and uses. Simple, intuitive and clear configuration and control via the free BEGA Smart app.

Find out more at [bega.com/smart](https://www.bega.com/smart)



DALI system components

DALI was designed specifically for space-specific control in building automation systems. A priority is the user-friendly control of light. DALI products are based on the EN 62386 standard. Our DALI system components are compatible with all commercially available DALI products. This ensures that actuators and sensors from other manufacturers can also be integrated into the system.

Find out more at bega.com/dali



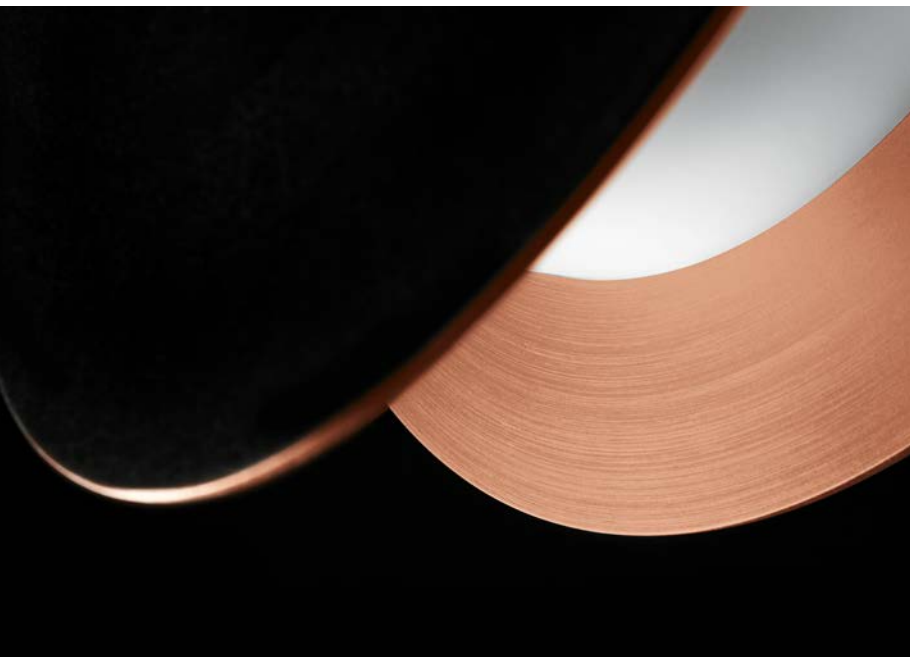

STUDIO LINE

Versatile solutions
for more ambiance

Distinctive and expressive – STUDIO LINE luminaires create a pleasant and sophisticated lighting atmosphere. The metallic inside colours contrast beautifully with the exterior finish – especially when illuminated. Based on their reliable, high-quality LED technology and perfect finishes, STUDIO LINE luminaires are the perfect choice for planning tasks for private living spaces, shops or hotels, and wherever prestigious, stylish luminaires with efficient LED technology are needed.



Interior colour in copper

Interior colour in brass

Interior colour in aluminium



works with
BEGA Smart

BEGA system pendant luminaires – suitable for any installation situation

As a modular system, BEGA system pendant luminaires allow you to combine pendant luminaires with various installation components.

The electrical connection and suspension of a pendant luminaire on the ceiling are usually achieved by means of a canopy. Apart from providing safety-relevant protection against contact voltage, it also conceals the suspension and the cable connection.

However, structural conditions often require pendant luminaires to be installed on different ceiling constructions. For example, the electrical connection of the luminaire and the suspension are supposed to be integrated into a suspended ceiling. Mounting and installation on sloping ceilings can also be a requirement, as can installation of the pendant luminaires in a track system.

From Page 194 onwards, you can learn more on this topic.



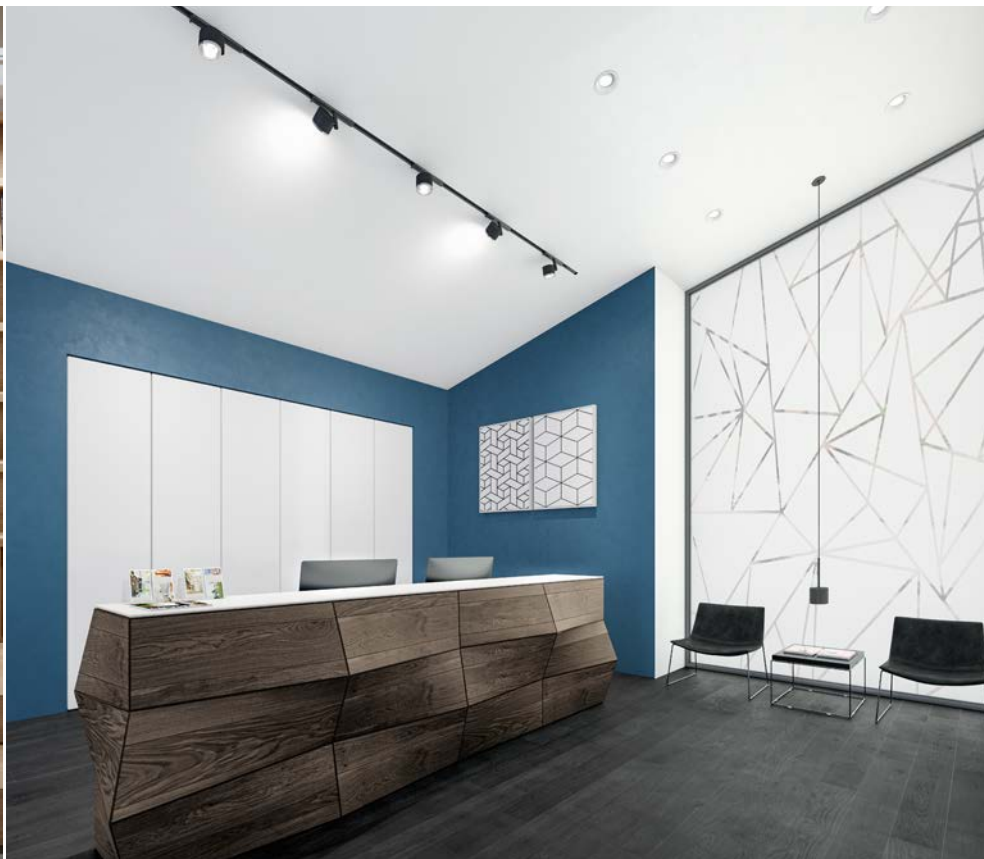

Track spotlights Full lighting flexibility

BEGA track spotlights come in a powerful range of ready-to-use illumination devices for integration in 3-phase Eurostandard Plus® track systems.

Choose from a broad and varied selection of light outputs and light distributions to find the right spotlights for your requirements – 3000 or 4000 Kelvin, Tunable White or RGBW. Benefit from the light and product quality of our BEGA Hybrid Optics® technology. Use optical diffuser filters or our BEGA zoom spotlights with infinitely adjustable half beam angle for more flexibility.

Learn more from Page 68 onwards.





Large-area luminaires







We also offer a great selection of large-area luminaires for large spaces.



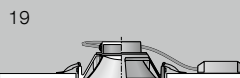
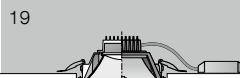
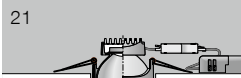

For the interior design of such spaces, we offer BEGA large-area luminaires as ceiling, recessed ceiling, wall or pendant luminaires. These are luminaires that were designed specifically for the illumination of large interior spaces with regard to their light output and size. Large-area luminaires add character and structure to large interior spaces individually, or when arranged in groups.





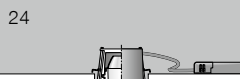
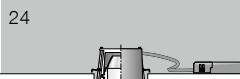
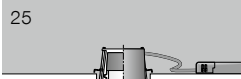
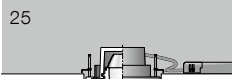





Recessed ceiling luminaires · Downlights

This summary of our recessed ceiling luminaires and downlights for indoors provides a compact and brief overview of all the important product data. It enables you to find a series quickly and compare products easily. Current values and other technical data can be found in the product data sheet of each individual luminaire on our website. The required installation depths can be found in the instructions for use for these luminaires. Please take these into account during your planning.

Page	19	19	21	21
				
	PRIMA Recessed ceiling luminaires Downlight	PRIMA Recessed ceiling luminaires Downlights	Recessed ceiling luminaires Downlights	Recessed ceiling luminaires Downlight
Power supply unit	external included · on/off	external included · on/off	external incl. · phase-dimmable	external incl. · phase-dimmable
Colour temperature	3000 K · 4000 K	3000 K · 4000 K	2700 K · 3000 K	2700 K · 3000 K
CRI	>90	>90	>90	>90
Luminaire luminous flux	1040 – 2000 lm	710 – 1285 lm	540 – 2040 lm	960 – 2010 lm
Size	Ø 180 · 235 mm	9 155 · 180 mm	Ø 64 · 78 mm	Ø 78 mm
				

Page	24	24	25	25
				
	ACCENTA PURE Recessed ceiling luminaires	ACCENTA Recessed ceiling luminaires	ACCENTA Recessed ceiling luminaires	ACCENTA VARIO Recessed ceiling luminaires
Power supply unit	external included · on/off · DALI	external included · on/off · DALI	external included · on/off · DALI	external included · on/off · DALI
Colour temperature	2700 K · 3000 K	2700 K · 3000 K	2700 K · 3000 K	2700 K · 3000 K
CRI	>90	>90	>90	>90
Luminaire luminous flux	570 lm	605 lm	650 lm	605 lm
Size	Ø 80 mm	Ø 80 mm	Ø 80 mm	Ø 105 mm
				

Page	28	28	29	29
				
	Recessed ceiling luminaires Downlight	Recessed ceiling luminaires Downlight	Recessed ceiling luminaires Downlight	Recessed ceiling luminaires Downlight
	flush-mounted installation BEGA Hybrid Optics® BEGA Constant Optics®	surface-mounted installation BEGA Hybrid Optics® BEGA Constant Optics®	BEGA Hybrid Optics® BEGA Constant Optics®	BEGA Hybrid Optics®
Power supply unit	on/off · DALI	on/off · DALI	external included · DALI	on/off · DALI
Colour temperature	3000 K	3000 K	3000 K	3000 K
CRI	>80 · >90	>80 · >90	>90	>90
Luminaire luminous flux	950 – 3535 lm	840 – 3535 lm	330 – 3520 lm	960 – 1465 lm
Size	Ø 115 · 130 · 175 mm	Ø 140 · 155 · 200 mm	Ø 110 · 145 · 220 · 260 mm	Ø 140 · 190 mm
				

Light distribution



narrow beam



wide beam







very wide beam





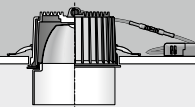
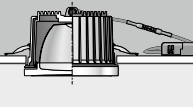
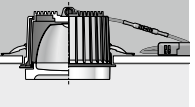
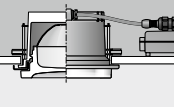



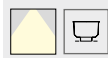

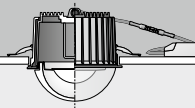
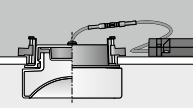
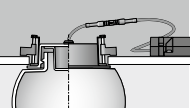
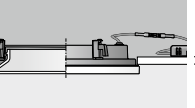
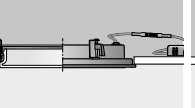
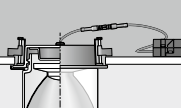

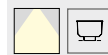

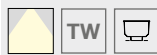

asymmetrical

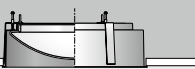
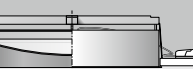
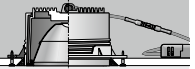
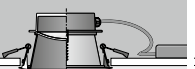
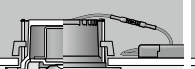

adjustable

Page	32	32	33	33
				
	Recessed ceiling luminaires Downlights Direct and indirect light	Recessed ceiling luminaires Downlights	Recessed ceiling luminaires Downlights	Recessed ceiling luminaires Downlights Protection class IP 65
PSU	on/off · DALI	on/off · DALI	on/off · DALI	on/off · DALI
Colour temperature	3000 K	3000 K	3000 K	3000 K · 4000 K
CRI	>90	>90	>90	>90
Luminaire luminous flux	835 · 1835 lm	795 · 1725 lm	760–1725 lm	260–1445 lm
Size	Ø 145 · 205 mm	Ø 145 · 205 mm	Ø 145 · 205 mm	Ø 80 · 115 · 155 · 185 mm
				

Page	36	37	37	40	41	43
						
	Recessed ceiling luminaires	Recessed ceiling luminaires Tunable white luminaires	Recessed ceiling and wall luminaires	Recessed ceiling and wall luminaires Tunable white luminaires	Recessed ceiling and wall luminaires Tunable white luminaires	Recessed ceiling luminaires Downlights Direct and indirect light Tunable white luminaires
PSU	on/off · DALI	on/off · DALI	on/off · DALI	on/off · DALI	on/off · DALI	on/off · DALI
Colour temperature	3000 K	3000 K · 2700–6500 K	3000 K	3000 K · 4000 K · 2700–6500 K	3000 K · 4000 K · 2700–6500 K	3000 K · 2700–6500 K
CRI	>90	>90	>90	>90	>90	>90
Luminaire luminous flux	970 · 1055 lm	710–3515 lm	830–1580 lm	590–3085 lm	460–2955 lm	485–2130 lm
Size	Ø 155 mm	Ø 135 · 160 · 180 · 225 · 265 mm	Ø 200 · 250 · 300 mm	Ø 185 · 260 · 345 · 435 mm	Ø 180 · 255 · 340 · 430 mm	Ø 130 · 150 · 170 · 220 mm
						

Page	46	47	50	50	51	53
						
	Recessed ceiling luminaires	Recessed ceiling luminaires Large-area luminaires	Recessed ceiling luminaires Flush-mounted installation	Recessed ceiling luminaires Surface-mounted installation	Recessed ceiling luminaires	Recessed ceiling luminaires
PSU	on/off · DALI	External, included · DALI	on/off · DALI	External, included · on/off · DALI	on/off · DALI	on/off · DALI
Colour temperature	3000 K	3000 K	3000 K	3000 K	3000 K	3000 K
CRI	>90	>90	>90	>90	>90	>90
Luminaire luminous flux	1350–3595 lm	7045–10 520 lm	805–1860 lm	400–1555 lm	775–1220 lm	360–820 lm
Size	Ø 295 · 395 · 465 mm	Ø 645 · 900 mm	Ø 115 · 130 · 175 mm	Ø 108 · 130 · 150 mm	Ø 140 · 190 mm	Ø 80 mm · □ 85 mm
						



PRIMA RECESSED CEILING LUMINAIRES · DOWNLIGHTS

Economical models in a round or square shape

The luminaires of the PRIMA series are designed for all applications requiring reliable technology and high cost efficiency. Attractive investment costs and exemplary lighting values are just as much part of the performance characteristics of this model series, as is the BEGA LED technology including all of its warranty promises.

The luminaires, which we offer as round or square designs, can be installed in suspended ceilings quickly and easily.

With two selectable colour temperatures, a colour rendering index greater than 90 and a symmetrical or asymmetrical wide beam light distribution let the lighting technology of these luminaires truly stand out. The electric connection is made directly to the external on/off power supply units, which are included in the scope of delivery.

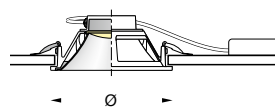

Size
Ø 180 · 235 mm

Installation depth
90 · 110 mm

Luminaire luminous flux
1040 – 2000 lm

Connected wattage
12.0 · 23.0 W

Colour temperature
3000 K · 4000 K

LED module

Colour rendering index
CRI > 90

External PSU included
on/off

Luminaire colour



Light distribution



Q P0224

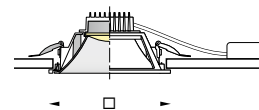

Size
□ 155 · 180 mm

Installation depth
80 · 90 mm

Luminaire luminous flux
710 – 1285 lm

Connected wattage
8.7 · 17.5 W

Colour temperature
3000 K · 4000 K

LED module

Colour rendering index
CRI > 90

External PSU included
on/off

Luminaire colour



Light distribution



Q P0135

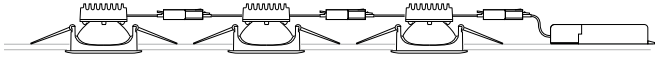

RECESSED CEILING LUMINAIRES · DOWNLIGHTS

Small but powerful

These small, recessed ceiling luminaires are helpful problem solvers for many lighting scenarios. Choose between ready-to-connect sets consisting of three or six luminaires, or simply select the number of single luminaires you will need for your planning project. Optionally available with fixed or adjustable light distribution. The sets contain everything you will need. The connection cables between the luminaires and a matching phase-dimmable power supply unit are also included. Simply install and connect, and your lighting system is ready. Their low installation depth makes them suitable for most suspended

ceilings. They are available in two installation sizes for recessed openings of 57 or 68 millimetres. Specifically for the standard recessed opening of 68 millimetres, the downlight sets are a practical replacement solution for existing older lighting systems. Perfect for economical lighting design with energy-efficient and lasting LED technology.

The two-metre connection cables between the downlights of the sets come with convenient plug connectors to ensure a quick installation. The downlights are available in three light distribution options: symmetrical very wide beam, symmetrical wide beam or asymmetrical.



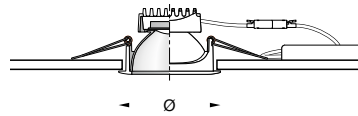

Size

Ø 64 · 78 mm

Recessed opening

Ø 57 · 68 mm

Installation depth

48 mm

Luminaire luminous flux

540 – 2040 lm

Connected wattage

8.2 – 33.0 W

Half beam angle

30° – 53°

Colour temperature

2700 K 3000 K

LED module

Colour rendering index

CRI > 90

External power supply unit included

Phase-dimmable

Ceiling trim ring finish



Light distribution



Q P0183

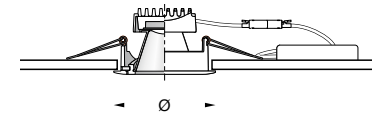

Adjustable
0° – 30°

Size

Ø 78 mm

Recessed opening

Ø 68 mm

Installation depth

48 mm

Luminaire luminous flux

960 – 2010 lm

Connected wattage

16.0 · 33.0 W

Half beam angle

40° · 53°

Colour temperature

2700 K 3000 K

LED module

Colour rendering index

CRI > 90

External power supply unit included

Phase-dimmable

Ceiling trim ring finish



Light distribution



Q P0276

ACCENTA RECESSED CEILING LUMINAIRES

Accented lighting

Small, compact luminaires with high-end LED technology for installations in suspended ceilings with 68-mm cut-outs.

The installation depth of just 48 mm is particularly well suited for use in construction projects where every millimetre counts. In addition to their compact dimensions, the technical lighting characteristics of the models in this series deserve special mention. Just as remarkable are the two colour temperatures to choose from, the excellent colour rendering and the choice between on/off or DALI controllable power supply units.

These small downlights do not just score highly in terms of technology and quality – there are also plenty of design features to choose from.

The luminaires come with pure and clear crystal glass for a brilliant play of light, or with opal glass for a gentler and more uniform light effect.

The adjustable ACCENTA VARIO for ceiling cut-outs with a diameter of 95 mm are also suitable for use in slanted ceilings. In addition to updating the efficiency of existing lighting systems, ACCENTA recessed ceiling luminaires are suitable for planning assignments in private homes, shops or hotels and wherever the objective is to use attractive luminaires with efficient and long-lasting LED technology.





Q P 0212

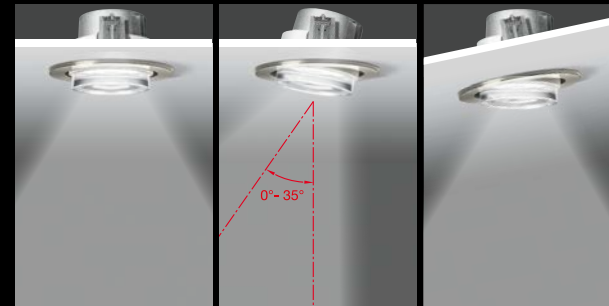

ACCENTA VARIO luminaires allow the adjustment of their beam direction from 0° to 35° and are particularly well suited for use in slanted ceilings.





ACCENTA PURE

Recessed ceiling luminaires

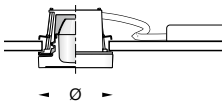

Size

Ø 80 mm

Recessed opening

Ø 68 mm

Luminaire luminous flux

570 lm

Connected wattage

10.4 W

Colour temperature

2700 K · 3000 K

LED module

Colour rendering index

CRI >90

External power supply unit included

on/off · DALI controllable

Material

Partially frosted crystal glass

Q P0236



ACCENTA

Recessed ceiling luminaires

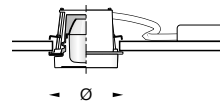

Size

Ø 80 mm

Recessed opening

Ø 68 mm

Luminaire luminous flux

605 lm

Connected wattage

10.4 W

Colour temperature

2700 K · 3000 K

LED module

Colour rendering index

CRI >90

External power supply unit included

on/off · DALI controllable

Material

Partially frosted crystal glass

Ceiling trim ring finish



Q P0118



Adjustable
0°–35°

ACCENTA

Recessed ceiling luminaires

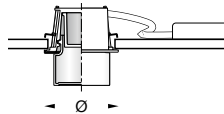

Size

Ø 80 mm

Recessed opening

Ø 68 mm

Luminaire luminous flux

650 lm

Connected wattage

7.5 W

Colour temperature

2700 K · 3000 K

LED module

Colour rendering index

CRI >90

External power supply unit included

on/off · DALI controllable

Material

three-ply opal glass

Ceiling trim ring finish



Q P0270

ACCENTA VARIO

Recessed ceiling luminaires

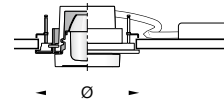

Size

Ø 105 mm

Recessed opening

Ø 95 mm

Luminaire luminous flux

605 lm

Connected wattage

10.4 W

Colour temperature

2700 K · 3000 K

LED module

Colour rendering index

CRI >90

External power supply unit included

on/off · DALI controllable

Material

Partially frosted crystal glass

Ceiling trim ring finish



Light distribution



Q P0212

RECESSED CEILING LUMINAIRES

Flush, surface-mounted or partially recessed

These downlights come in two designs and utilise the advantages of our highly efficient BEGA Hybrid Optics® technology. The lens-reflector combination enjoys all the benefits of sophisticated lens and reflector technology. The resulting optical systems are highly efficient, feature low-loss and optimized glare suppression as well as very compact dimensions. We exclusively use age-resistant materials like glass, aluminium and silicone in these products.

The spherical luminaires with asymmetrical light distribution can be rotated 360 degrees around their vertical luminaire axis to illuminate wall surfaces. These model series are available in various sizes, half beam angles and light outputs to suit whatever lighting design you are planning.



BEGA Hybrid Optics®

The perfect match

BEGA utilises BEGA Hybrid Optics® technology to maximise the efficiency of technical indoor and outdoor luminaires. Luminaires with this optical system rely on the perfect interplay of precisely dimensioned reflectors with a pure aluminium finish and ultra-clear silicone lenses.

In these luminaires, virtually every beam of light emitted by the LED modules is captured by the BEGA Hybrid Optics® technology, directed and used for optimal light distribution. That is the biggest difference between hybrid optics and conventional light deflection methods, in which much of the light leaves the luminaire without being deflected.

LED technology from
our own manufacture



Durable and virtually wear-free
ultra-clear silicone lenses for
extreme conditions

Precisely dimensioned and refined
reflectors with a pure aluminium
finish



Q P 0220

The adjustable luminaires of this model series allow an adjustment of their beam direction from 0° to 30° and are particularly well suited for use in slanted ceilings.

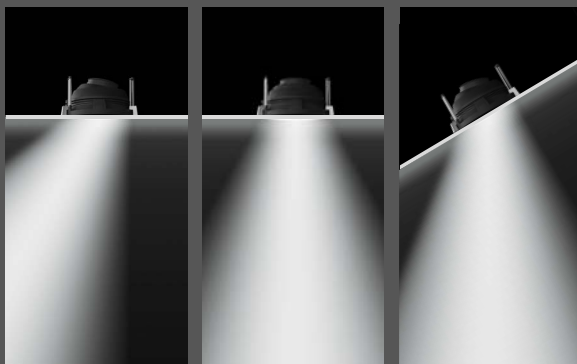



Flush-mounted
installation



Surface-mounted
installation



Also available with zoom optics

Recessed ceiling luminaires · Downlights

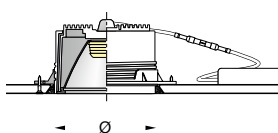

Size
Ø 115 · 130 · 175 mm

Installation depth
95–130 mm

Luminaire luminous flux
950–3535 lm

Connected wattage
9.8–29.0 W

Half beam angle
14°–74°

Colour temperature
3000 K

LED module

Colour rendering index
CRI >80 · >90

External power supply unit
on/off · DALI controllable

Optical system
BEGA Hybrid Optics®
BEGA Constant Optics®

Material
Safety glass

**Ceiling trim ring
finish**



Light distribution



Q P0116

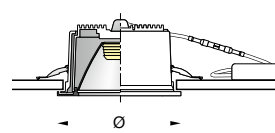

Size
Ø 140 · 155 · 200 mm

Installation depth
95–130 mm

Luminaire luminous flux
840–3535 lm

Connected wattage
9.8–29.0 W

Half beam angle
14°–74°

Colour temperature
3000 K

LED module

Colour rendering index
CRI >80 · >90

External power supply unit
on/off · DALI controllable

Optical system
BEGA Hybrid Optics®
BEGA Constant Optics®

Material
Safety glass

**Ceiling trim ring
finish**



Light distribution



Q P0173



Surface-mounted
installation

Adjustable
0°–30°



Partially
recessed

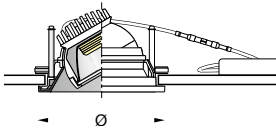

Size
Ø 110 · 145 · 220 · 260 mm

Installation depth
80–155 mm

Luminaire luminous flux
330–3520 lm

Connected wattage
5.1–38.0 W

Half beam angle
18°–64°

Colour temperature
3000 K

LED module

Colour rendering index
CRI >90

External PSU included
DALI controllable

Optical system
BEGA Hybrid Optics®
BEGA Constant Optics®

BEGA Thermal Management®

Accessories
Installation housing for concrete ceilings
Exchangeable lenses

Material
Safety glass

Luminaire colour



Light distribution



Q P 0220

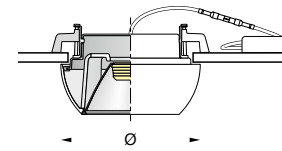

Size
Ø 140 · 190 mm

Installation depth
55 mm

Luminaire luminous flux
960–1465 lm

Connected wattage
10.2 W · 13.7 W

Half beam angle
14°–61°

Colour temperature
3000 K

LED module

Colour rendering index
CRI >90

External power supply unit
on/off · DALI controllable

Optical system
BEGA Hybrid Optics®

Accessory
Install. housing for concrete ceilings

Material
Safety glass

Luminaire colour



Light distribution



Q P 0268



RECESSED CEILING LUMINAIRES · DOWNLIGHTS

Glass of unrivalled quality

Recessed ceiling downlights with hand-crafted glass covers that are one-of-a-kind pieces of glass art and directly impact the lighting atmosphere in the room.

The luminaires with hand-blown, three-ply opal glass create a softer and uniform light distribution.

The gentle lighting atmosphere promises optimal visual comfort.

The luminaires with partially frosted crystal glass, on the other hand, feature a higher glass thickness. When lit, they produce a brilliant and faceted play of light. Both versions illuminate the room and the installation surface, creating an attractive light ambiance.

The luminaire connects to the power supply unit via a convenient plug connector.

The electric installation can therefore be finished before the final mounting of the luminaires – for example before paint works are done on the ceiling.







Recessed ceiling luminaires · Downlights

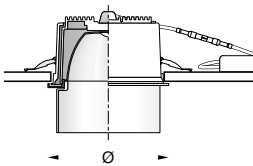

Size

Ø 145 · 205 mm

Installation depth

95 · 130 mm

Luminaire luminous flux

835 · 1835 lm

Connected wattage

9.8 · 20.0 W

Half beam angle

50°

Colour temperature

3000 K

LED module

Colour rendering index

CRI >90

External power supply unit

on/off · DALI controllable

Optical system

BEGA Constant Optics®

Material

Three-ply opal glass

Ceiling trim ring finish



Q P0164

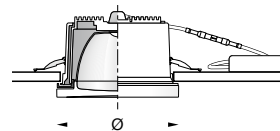

Size

Ø 145 · 205 mm

Installation depth

95 · 130 mm

Luminaire luminous flux

795 · 1725 lm

Connected wattage

9.8 · 20.0 W

Half beam angle

48° · 59°

Colour temperature

3000 K

LED module

Colour rendering index

CRI >90

External power supply unit

on/off · DALI controllable

Optical system

BEGA Constant Optics®

Material

Partially frosted crystal glass

Q P0179



Protection class
IP 65

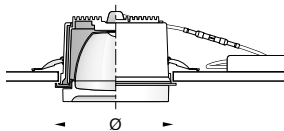

Size
Ø 145 · 205 mm

Installation depth
95 · 130 mm

Luminaire luminous flux
760 · 1725 lm

Connected wattage
9.8 · 20.0 W

Half beam angle
50° · 55°

Colour temperature
3000 K

LED module

Colour rendering index
CRI > 90

External power supply unit
on/off · DALI controllable

Optical system
BEGA Constant Optics®

Material
Partially frosted crystal glass

Ceiling trim ring finish



Q P0141

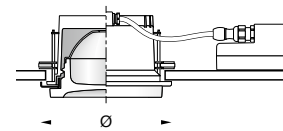

Size
Ø 80 · 115 · 155 · 185 mm

Installation depth
70–95 mm

Luminaire luminous flux
260–1445 lm

Connected wattage
6.0–28.5 W

Half beam angle
40°–51°

Colour temperature
3000 K

LED module

Colour rendering index
CRI > 90

External power supply unit
on/off · DALI controllable

Accessory
Installation housing
for concrete ceilings

Material
Partially frosted crystal glass

Ceiling trim ring finish



Q P0160



RECESSED CEILING AND WALL LUMINAIRES

The glass defines the light

These recessed luminaires are ready for use in many application scenarios where luminaires are to be installed in suspended ceilings or in drywalls.

Unshielded luminaires with various types of glass that allow geometric as well as free, creative arrangements for a multitude of sophisticated lighting solutions. Each type of glass creates its own lighting atmosphere.

The luminaires with clear crystal glass and white internal diffuser create a completely novel, multi-dimensional light effect, while the ice crystal glass separates the light of the LED into individual, small light points. The result is a play of light that is as brilliant as it is multifaceted.

The two luminaire series with hand-blown opal glass create a soft and gentle light and attractive lighting ambiance.

Some luminaires are additionally available with variable colour temperature (tunable white).



Ice crystal glass

Three-ply opal glass





Recessed ceiling luminaires

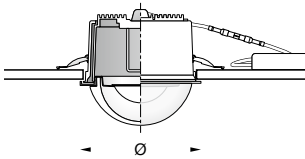

Size

Ø 155 mm

Installation depth

105 mm

Luminaire luminous flux

970 · 1055 lm

Connected wattage

13.5 W

Colour temperature

3000 K

LED module

Colour rendering index

CRI >90

External power supply unit

on/off · DALI controllable

Material

Crystal glass

Ice crystal glass

Ceiling trim ring finish



Page 66



Page 133

Q P 0205



Tunable
white

Recessed ceiling luminaires

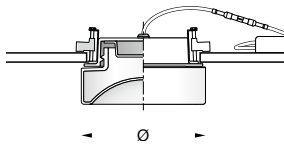

Size
Ø 135 · 160 · 180 · 225 · 265 mm

Installation depth
45 · 60 mm

Luminaire luminous flux
710–3515 lm

Connected wattage
7.1–41.0 W

Colour temperature
3000 K or
Tunable white 2700–6500 K

LED module

Colour rendering index
CRI >90

External power supply unit
on/off · DALI controllable

BEGA Thermal Management®

Accessory
Installation housing
for concrete ceilings

Material
Three-ply opal glass



Page 67



Page 179

Q P0271



Recessed ceiling and wall luminaires

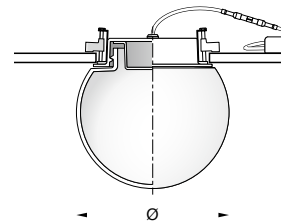

Size
Ø 200 · 250 · 300 mm

Installation depth
45–60 mm

Luminaire luminous flux
830–1580 lm

Connected wattage
10.0–16.3 W

Colour temperature
3000 K

LED module

Colour rendering index
CRI >90

External power supply unit
on/off · DALI controllable

BEGA Thermal Management®

Accessory
Installation housing
for concrete ceilings

Material
Three-ply opal glass



Page 67



Page 188

Q P0198

RECESSED CEILING AND WALL LUMINAIRES

Exact shapes: flat or flush-mounted recessed luminaires

Luminaires for installation in suspended ceilings or drywalls, and in concrete ceilings using an installation housing. Unshielded luminaires that can be used as a surface-mounted or nearly flush version.

The various luminaire diameters allow geometric patterns as well as free, sophisticated arrangements with a mix of sizes.

The flat glass covers seem to float and illuminate the room and also the installation surface in their immediate vicinity.

When lit, the virtually flush luminaires of this model series create an interesting contrast effect between the ceiling or wall and the actual luminaire.

Choose on/off or DALI controllable power supply units for the two types of luminaires and from two available LED colour temperatures; or select luminaires with variable colour temperature (tunable white).



2700 Kelvin

3000 Kelvin

4000 Kelvin

6500 Kelvin

Colour temperature control with tunable white

In luminaires with variable colour temperature, the light colour is **infinitely variable**. The spectrum begins with a warm white light colour at 2700 Kelvin, which is similar to the light emitted by the conventional incandescent light bulb.

Neutral white light at 4000 Kelvin is traditionally used for office lighting. 6500 Kelvin generate cold white light, similar to daylight at noon.

Please visit www.bega.com/tunable-white for more information about tunable white

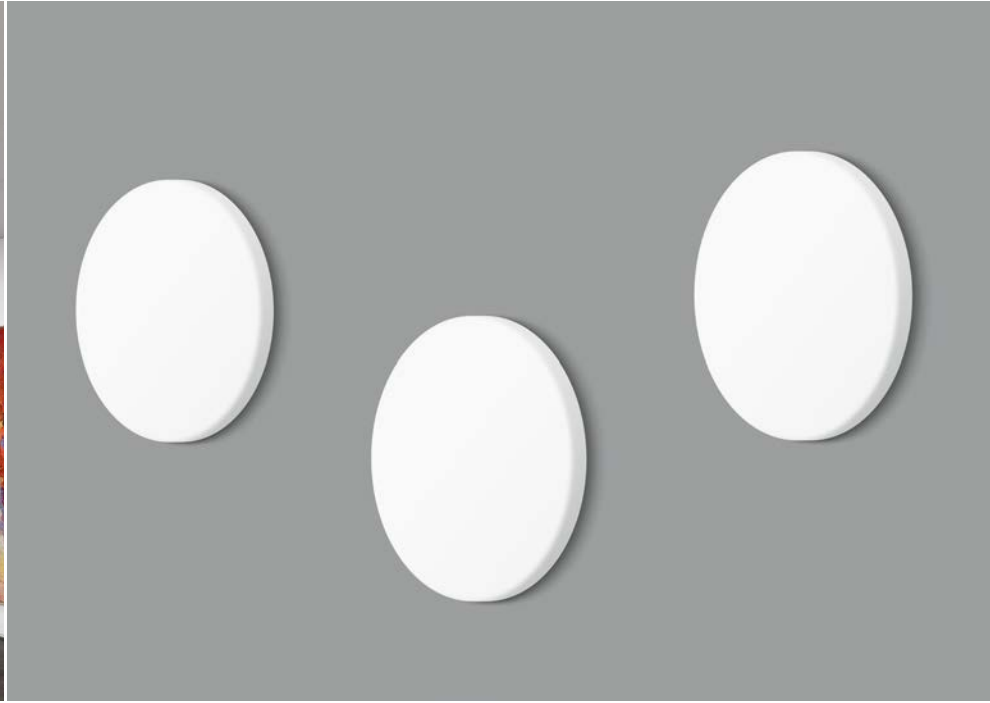



Tunable
white

Recessed ceiling and wall luminaires

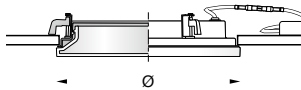

Size
Ø 185 · 260 · 345 · 435 mm

Installation depth
60 mm

Luminaire luminous flux
590–3085 lm

Connected wattage
9.8–49.0 W

Colour temperature
3000 K · 4000 K or
Tunable white 2700–6500 K

LED module

Colour rendering index
CRI > 90

External power supply unit
on/off · DALI controllable

BEGA Thermal Management®

Accessory
Installation housing
for concrete ceilings

Material
Three-ply opal glass

Q P0171



Tunable
white

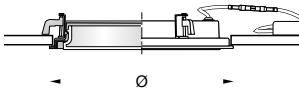

Size
Ø 180 · 255 · 340 · 430 mm

Installation depth
60 mm

Luminaire luminous flux
460–2955 lm

Connected wattage
9.8–49.0 W

Colour temperature
3000 K · 4000 K or
Tunable white 2700–6500 K

LED module

Colour rendering index
CRI > 90

External power supply unit
on/off · DALI controllable

BEGA Thermal Management®

Accessory
Installation housing
for concrete ceilings

Material
Three-ply opal glass

Ceiling trim ring finish



Q P 0255



These luminaires are suitable
for ceiling and wall installation.



RECESSED CEILING LUMINAIRES · DOWNLIGHTS

The luminaire within the luminaire

Dual light distribution is the answer: recessed ceiling luminaires that emit light into the room in two ways. The powerful light portion directed downward is bundled at the centre of the reflector via an integrated focusing/diffusing lens made of crystal glass. At the same time, some of the diffuse light percentage is used for the illumination of the luminaire glass and for vertical illuminance. The mix of downward directed and vertical luminous intensity ensures excellent visual comfort.

Choose between luminaires with clear crystal glass for brilliant light or hand-blown opal glass for a soft and uniform light distribution. Hand-crafted glass covers that are one-of-a-kind pieces of glass art and directly impact the lighting atmosphere in the room.



Dual light distribution

A light source generates a downward directed portion of light centrally underneath the luminaire as well as a diffuse light percentage in the immediate vicinity.



Tunable
white



Tunable
white

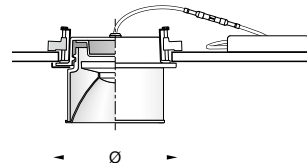

Page 63



Page 63

Size
Ø 130 · 150 · 170 · 220 mm

Installation depth
45 mm

Luminaire luminous flux
485–2130 lm

Connected wattage
7.2–24.3 W

Half beam angle
38°–46°

Colour temperature
3000 K or
Tunable white 2700–6500 K

LED module

Colour rendering index
CRI > 90

Power supply unit
on/off · DALI controllable

BEGA Thermal Management®

Accessory
Installation housing
for concrete ceilings

Material
Crystal glass
Three-ply opal glass

Ceiling trim ring finish



Q P 0185 · P 0265

Large-scale precision and ambiance

More than just light – these recessed ceiling luminaires turn functional suspended ceilings into eye-catching highlights. Atmospheric metal finishes in diameters between 300 and 900 millimetres generate warm or cool lighting effects. These two model series open up a multitude of new and creative design options. The uniform and pleasantly soft lighting atmosphere created in the room is truly memorable. Depending on the inside colour, there will be beautiful colour nuances that positively impact visual comfort and ambiance. During daylight hours, the metallic interior colour hues of the luminaire housings create a rich contrast against the ceiling. These luminaires from the STUDIO LINE luminaire series feature economical and reliable LED technology, paired with an impressive light output.

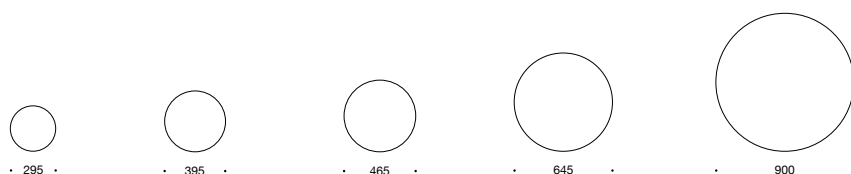

STUDIO LINE internal colour tones







STUDIO LINE

Recessed ceiling luminaires · Large-area luminaires

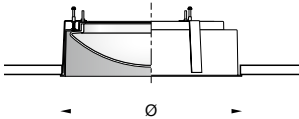

Size
Ø 295 · 395 · 465 mm

Installation depth
145 – 165 mm

Luminaire luminous flux
1350 – 3595 lm

Connected wattage
20.7 – 48.6 W

Colour temperature
3000 K

LED module

Colour rendering index
CRI > 90

External power supply unit
on/off · DALI controllable

BEGA Thermal Management®

Material
White, translucent synthetic cover

Inside colour



Q P0114



Page 84



Page 221



Page 227

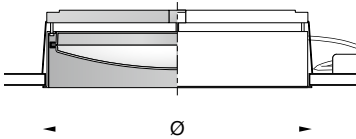

Size
Ø 645 · 900 mm

Installation depth
190 – 205 mm

Luminaire luminous flux
7045 – 10 520 lm

Connected wattage
74.0 · 86.0 W

Colour temperature
3000 K

LED module

Colour rendering index
CRI > 90

External power supply unit included
DALI controllable

BEGA Thermal Management®

Material
White, translucent synthetic cover

Inside colour



Q P0143



Page 87



Page 229

STUDIO LINE RECESSED CEILING LUMINAIRES

Flush, surface-mounted or partially recessed

Studio Line luminaires of this model series offer a variety of options for installation in suspended ceilings. They are available as flush or surface-mounted versions for ceiling installations. The partially recessed luminaires of this series highlight the light point in the ceiling. The luminaires from the STUDIO LINE series are characterised by a pleasant lighting atmosphere. They boast both economical and reliable LED technology as well as a fascinating interplay of different materials. The metallic inner colours reveal their true beauty when illuminated. Choose from eight colour combinations to match the luminaires to your interior. You can choose between on/off and DALI controllable power supply units. The luminaire connects to the relevant power supply unit via a convenient plug connector. The electric installation can therefore be finished before the final mounting of the luminaires – for example before paint works are done on the ceiling.



STUDIO LINE finishes

Velvet white or velvet black trim ring



White

Matt aluminium

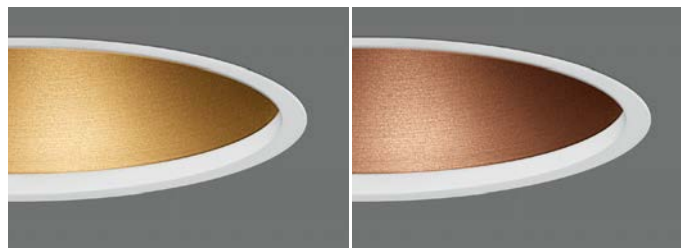

Matt brass

Matt copper





Flush-mounted
installation



Surface-mounted
installation



STUDIO LINE

Recessed ceiling luminaires

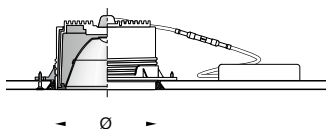

Size
Ø 115 · 130 · 175 mm

Installation depth
95–130 mm

Luminaire luminous flux
805–1860 lm

Connected wattage
9.8–20.0 W

Half beam angle
24°–43°

Colour temperature
3000 K

LED module

Colour rendering index
CRI > 90

External power supply unit
on/off · DALI controllable

Trim ring



Inside colour



Q P0175

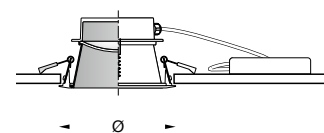

Size
Ø 108 · 130 · 150 mm

Installation depth
72 · 80 · 90 mm

Luminaire luminous flux
400–1555 lm

Connected wattage
9.2–20.0 W

Colour temperature
3000 K

LED module

Colour rendering index
CRI > 90

External PSU included
on/off · DALI controllable

Trim ring



Inside colour



Q P0148

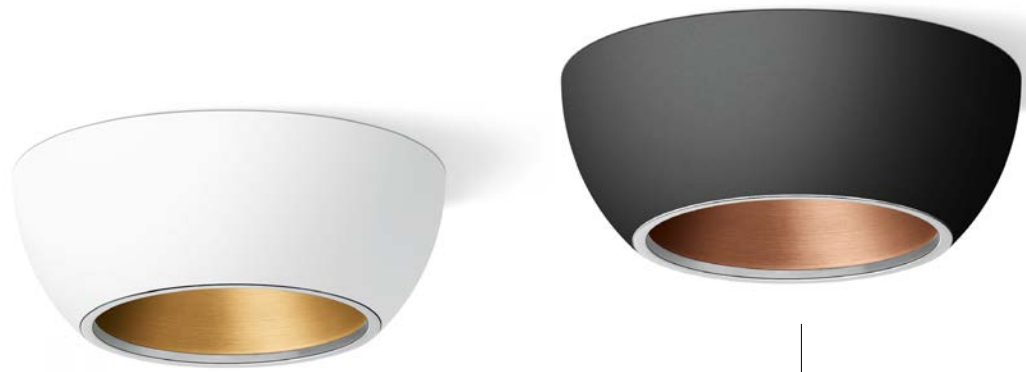

Partially recessed

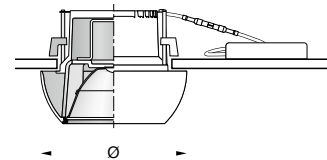

Size
Ø 140 · 190 mm

Installation depth
55 mm

Luminaire luminous flux
775–1220 lm

Connected wattage
10.2–13.8 W

Colour temperature
3000 K

LED module

Colour rendering index
CRI > 90

External power supply unit
on/off · DALI controllable

Accessory
Install. housing for concrete ceilings

Outside colour



Inside colour



Q P 0178

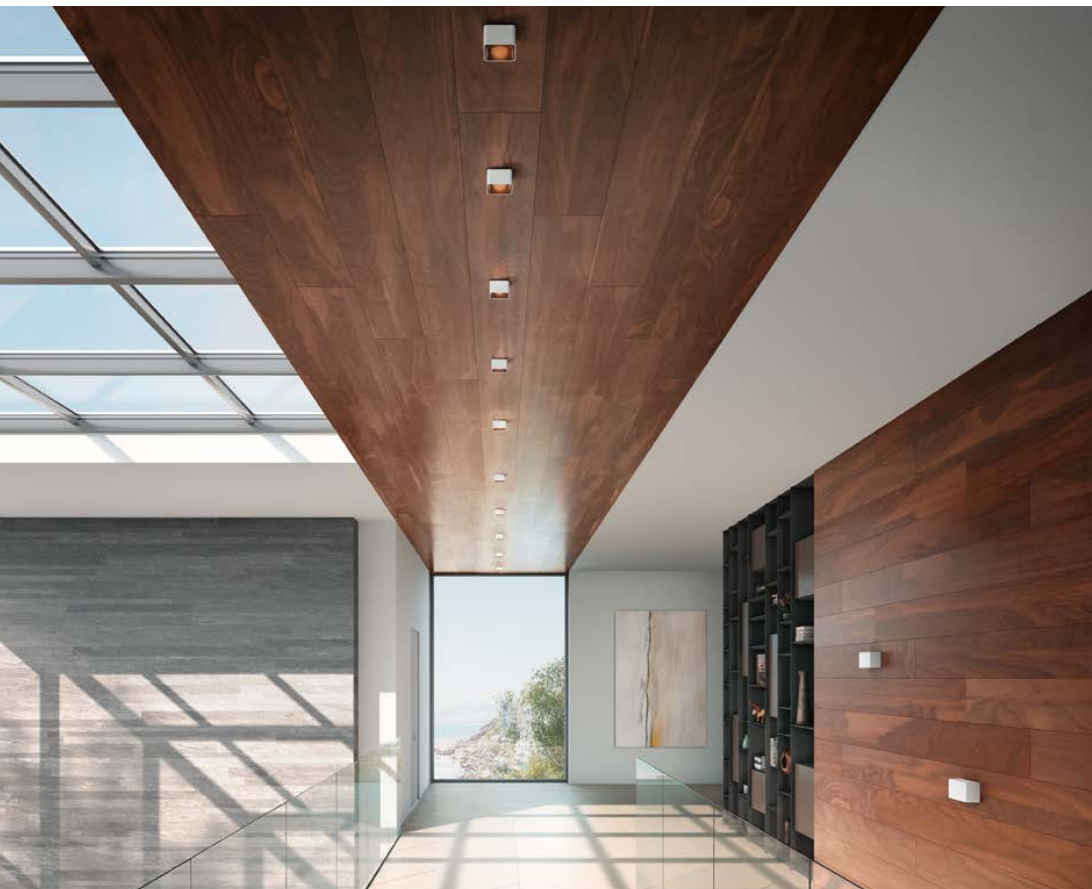

STUDIO LINE

Cylindrical or cuboid-shaped recessed ceiling luminaires



Small and compact luminaires for installation in suspended ceilings. The downward directed light of these recessed ceiling luminaires is shielded laterally by a round or square metal shield – particularly well suited for applications where the aim is to create islands of light with shielded light. Arranged in rows, these luminaires provide glare-free illumination for corridors and hallways. They are part of the STUDIO LINE series and

feature economical and reliable LED technology as well as a fascinating interplay of various materials.

These timeless light sources with metallic inside colours look particularly beautiful when lit. These luminaires can be paired with on/off or DALI controllable power supply units that are connected using easy plug connectors.



Partially recessed

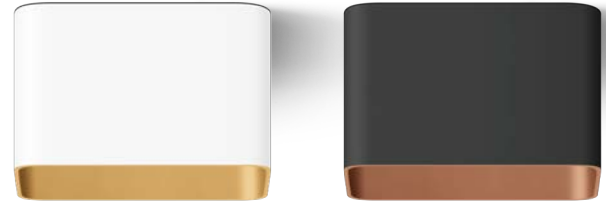

Partially recessed



Page 81

Page 173



Page 81

Page 172

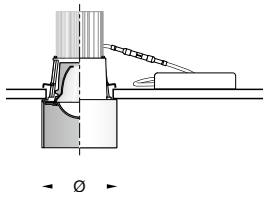

Size
Ø 80 mm

Recessed opening
Ø 68 mm

Installation depth
48 · 100 mm

Luminaire luminous flux
380 – 820 lm

Connected wattage
8.0 · 14.3 W

Colour temperature
3000 K

LED module

Colour rendering index
CRI > 90

External power supply unit
on/off · DALI controllable

Outside colour



Inside colour



Q P0124

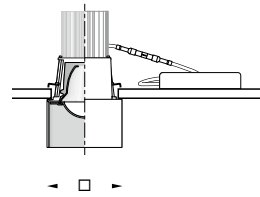

Size
□ 85 mm

Recessed opening
Ø 68 mm

Installation depth
48 · 100 mm

Luminaire luminous flux
360 – 820 lm

Connected wattage
8.0 · 14.3 W

Colour temperature
3000 K

LED module

Colour rendering index
CRI > 90

External power supply unit
on/off · DALI controllable

Outside colour



Inside colour



Q P0253



See Page 8 for more information about BEGA Vortex Optics®.

CEILING LUMINAIRES · DOWNLIGHTS

Economical and compact downlights

A model series with highly efficient ceiling luminaires that raise the bar in terms of economy and compact dimensions. These downlights utilise the advantages of our highly efficient BEGA Vortex Optics® technology. The patented reflectors (European Patent EP 3098504) ensure perfect light deflection by bundling the light, which in turn guarantees highest visual comfort.

This model series offers various sizes, half beam angles and light outputs to suit whatever lighting design you are planning. The high protection class (VDE 0100-compliant) makes these luminaires perfect for use in wet rooms, e.g. bathrooms, where this type of protection type is a requirement.

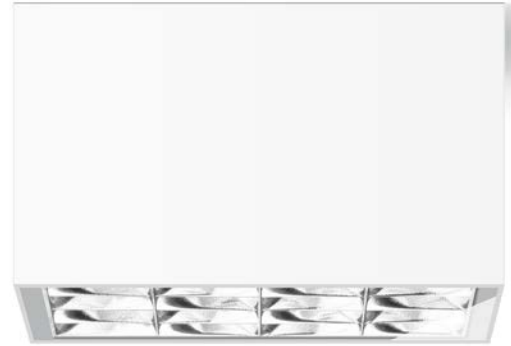

Protection class
IP 65

Size

□ 95 · 130 · 170 mm

Luminaire luminous flux

275–3300 lm

Connected wattage

4.1–36.2 W

Half beam angle

21°–48°

Colour temperature

3000 K · 4000 K

LED module

Colour rendering index

CRI > 90

Power supply unit

on/off · DALI controllable

Optical system

BEGA Vortex Optics®

Material

Safety glass

Light distribution



Q P 0197



Fully on target, with maximized light efficiency

These downlights come in two designs and utilise the advantages of our highly efficient BEGA Hybrid Optics® technology. The lens-reflector combination enjoys all the benefits of sophisticated lens and reflector technology. The resulting optical systems are highly efficient, feature low-loss and optimized glare suppression as well as very compact dimensions. We exclusively use age-resistant materials like glass, aluminium and silicone in these products.

The spherical luminaires with asymmetrical light distribution can be rotated 360 degrees around their vertical luminaire axis to illuminate wall surfaces. These model series are available in various sizes, half beam angles and light outputs to suit whatever lighting design you are planning.



BEGA Hybrid Optics® The perfect match

BEGA utilises BEGA Hybrid Optics® technology to maximise the efficiency of technical indoor and outdoor luminaires. Luminaires with this optical system rely on the perfect interplay of precisely dimensioned reflectors with a pure aluminium finish and ultra-clear silicone lenses.

In these luminaires, virtually every beam of light emitted by the LED modules is captured by the BEGA Hybrid Optics® technology, directed and used for optimal light distribution. That is the biggest difference between hybrid optics and conventional light deflection methods, in which much of the light leaves the luminaire without being deflected.

LED technology
from our own manufacture



Durable and virtually wear-free
ultra-clear silicone lenses for
extreme conditions



Precisely dimensioned
and refined reflectors with
a pure aluminium finish





Ceiling luminaires · Downlights

Size

Ø 140 · 190 mm

Luminaire luminous flux

960–1465 lm

Connected wattage

10.0 · 13.5 W

Half beam angle

14°–61°

Colour temperature

3000 K

LED module

Colour rendering index

CRI >90

Power supply unit

DALI controllable

Optical system

BEGA Hybrid Optics®

BEGA Thermal Management®

Material

Safety glass

Finish



Light distribution

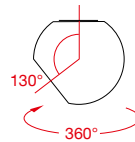

Q P0129



Page 29



Page 70



Page 198



Also available with
zoom optics



Size
Ø 90 · 120 · 135 · 180 mm

Luminaire luminous flux
370 – 3535 lm

Connected wattage
5.0 – 37.0 W

Half beam angle
14° – 74° or

with zoom optics

Colour temperature
3000 K

LED module

Colour rendering index
CRI > 80 · > 90

Power supply unit
on/off · DALI controllable

Optical system
BEGA Hybrid Optics®
BEGA Constant Optics®

BEGA Thermal Management®

Material
Safety glass

Finish



Light distribution



Q P 0211



Page 28



Page 70



Page 199



CEILING LUMINAIRES · DOWNLIGHTS

Captivating materials



This model series features high-quality, hand-crafted glass covers for ceiling downlights that are one-of-a-kind pieces of glass art and directly impact the lighting atmosphere in the room.

The downlight portion of the luminaires is generated by pure anodised aluminium reflectors. The partially frosted crystal glass feature a particularly high material thickness and cause the brilliant light to be distributed in a very wide beam.

The model series is available with various projections, half beam angles and light outputs to suit whatever lighting design you are planning.

You can furthermore choose between a velvet white and stainless steel housing finish.



Size
 Ø 120 · 135 · 180 mm

Luminaire luminous flux
 985 – 2080 lm

Connected wattage
 9.7 – 19.5 W

Half beam angle
 86° – 95°

Colour temperature
 2700 K · 3000 K

LED module

Colour rendering index
 CRI > 90

Power supply unit
 on/off · DALI controllable

BEGA Thermal Management®

Material
 Partially frosted crystal glass

Finish



Q P0137



Size
 Ø 120 · 135 · 180 mm

Luminaire luminous flux
 1630 – 2700 lm

Connected wattage
 19.4 – 34.5 W

Half beam angle
 49° – 55°

Colour temperature
 2700 K · 3000 K

LED module

Colour rendering index
 CRI > 90

Power supply unit
 DALI controllable

Optical system
 BEGA Constant Optics®

BEGA Thermal Management®

Material
 Partially frosted crystal glass

Finish



Q P0130



Page 119



Page 177

The luminaire within the luminaire

Dual light distribution is the answer: Ceiling luminaires that emit their light into the room in two ways. The powerful light portion directed downward is bundled at the centre of the reflector via an integrated focusing/diffusing lens made of crystal glass. At the same time, some of the diffuse light percentage is used for the illumination of the luminaire glass and for vertical illuminance. The mix of downward directed and vertical luminous intensity ensures excellent visual comfort.

Choose between luminaires with clear crystal glass for brilliant light or hand-blown opal glass for a soft and uniform light distribution. Hand-crafted glass covers that are one-of-a-kind pieces of glass art and directly impact the lighting atmosphere in the room.

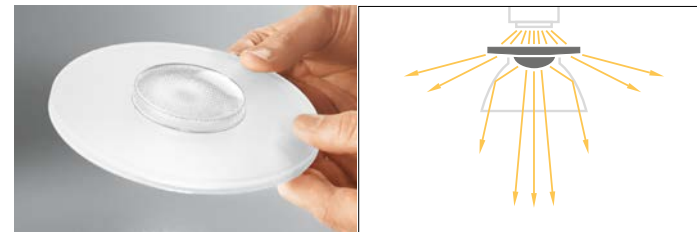

Dual light distribution

A light source generates a downward directed portion of light centrally underneath the luminaire as well as a diffuse light percentage in the immediate vicinity.



**Size**

Ø 100 · 120 · 140 · 190 mm

Luminaire luminous flux

255–1560lm

Connected wattage

4.1–17.0 W

Half beam angle

40°–48°

Colour temperature

3000K

LED module**Colour rendering index**

CRI > 90

Power supply unit

on/off · DALI controllable

BEGA Thermal Management®**Material**

Crystal glass

Three-ply opal glass

Finish

Page 43



Page 43

Q P 0169 · P 0102

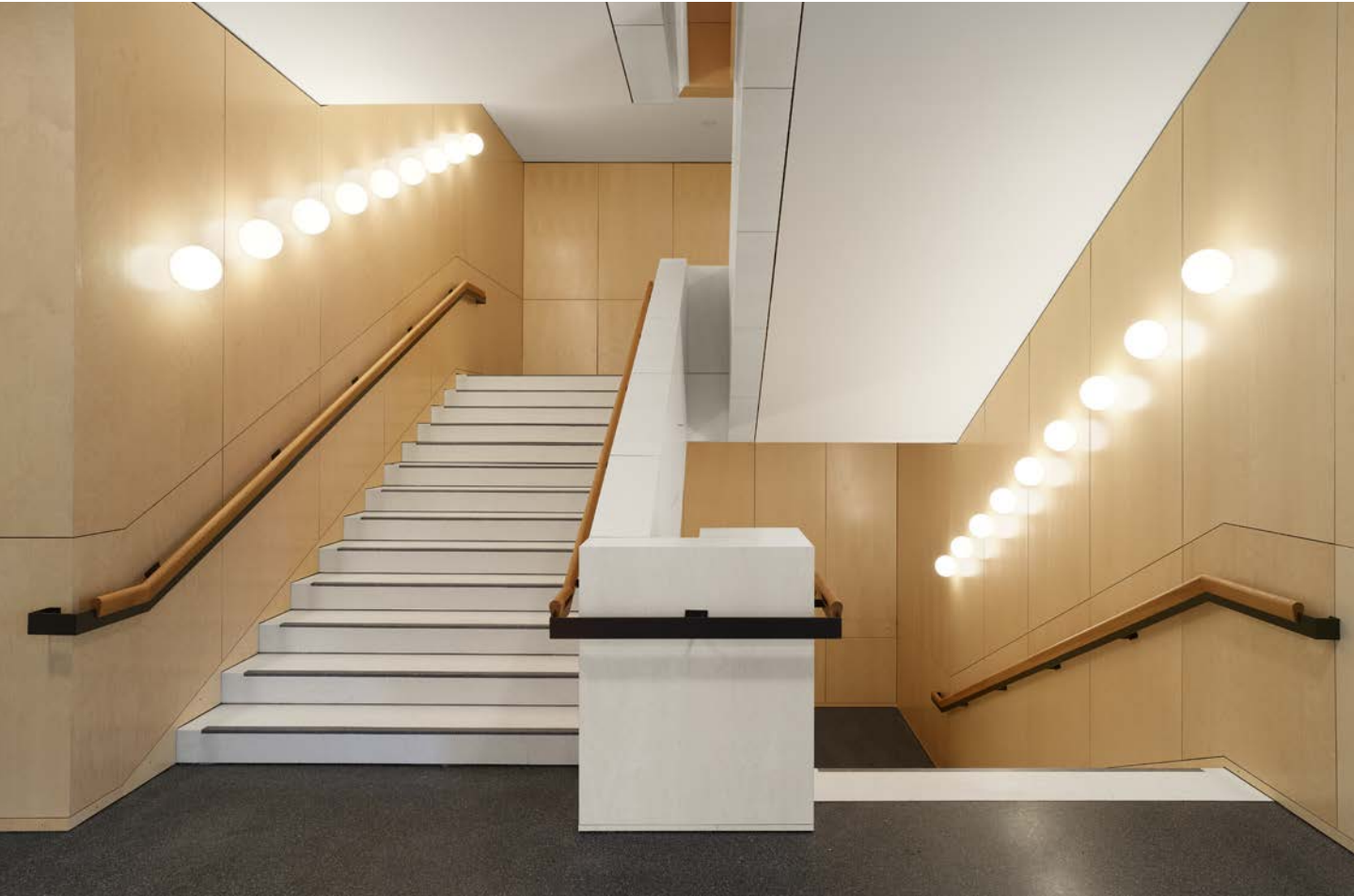

CEILING AND WALL LUMINAIRES

The glass defines the light

Three unshielded luminaire series with unusual luminaire glass covers create different types of lighting atmospheres, depending on the glass you choose.

The luminaires with clear crystal glass and white internal diffuser produce a completely novel, multi-dimensional light effect, while the ice crystal glass separates the light of the LED into individual, small light points. The result is a play of light that is as brilliant as it is multifaceted. The two luminaire versions with hand-blown opal glass create a soft and gentle light and attractive lighting ambiance.

Luminaires that allow for a multitude of sophisticated lighting solutions through geometrical or free, creative arrangements.





Ceiling luminaires

Size

Ø 135 mm

Luminaire luminous flux

1080 · 1225 lm

Connected wattage

13.5 W

Colour temperature

3000 K

LED module**Colour rendering index**

CRI > 90

Power supply unit

DALI controllable

BEGA Thermal Management®

Material

Crystal glass

Ice crystal glass

Finish

Page 36



Page 133

Q P 0237





Ceiling and wall luminaires

Size
Ø 100 · 120 · 140 · 190 mm

Luminaire luminous flux
310 – 1265 lm

Connected wattage
4.1 – 17.0 W

Colour temperature
3000 K

LED module

Colour rendering index
CRI > 90

Power supply unit
on/off · DALI controllable

BEGA Thermal Management®

Material
Three-ply opal glass

Finish



Page 37



Page 179

Q P0115

Size
Ø 200 · 250 · 300 mm

Luminaire luminous flux
670 – 2695 lm

Connected wattage
7.0 – 24.5 W

Colour temperature
2700 K · 3000 K

LED
LED module

Lamp
E 27 LED lamp included

Colour rendering index
CRI > 80 · > 90

Power supply unit
on/off

BEGA Thermal Management®

Material
Three-ply opal glass

Trim ring finish

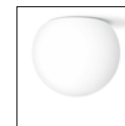

Page 37



Page 188

Q P0242

TRACK SPOTLIGHT

Full lighting flexibility

The BEGA track spotlights come in a powerful range of ready-to-use illumination devices that can be integrated in 3-phase Eurostandard Plus® track systems.

Choose from a broad and varied selection of light outputs and light distributions to find the right spotlights for your requirements – 3000 or 4000 Kelvin, tunable white or RGBW. You too can benefit from the light and product quality of our BEGA

Hybrid Optics® technology. Use optical diffuser filters or our BEGA zoom spotlights with adjustable half beam angle for more flexibility.

As an expansion solution, BEGA system pendant luminaires offer an extensive range of pendant luminaires for the integration in track systems. Additional information on BEGA Hybrid Optics® can be found on Page 14.





BEGA zoom spotlights feature infinite adjustment of the half beam angle between 15° and 50°. The ideal setting for the specific requirements can be conveniently selected and adjusted at any time using the rotating lens unit. Use optical diffuser filters as accessories to modify the factory-set light distribution: flat beam, symmetrically diffuse, asymmetrical.





BEGA Hybrid Optics®



BEGA Hybrid Optics®

Track spotlights with adapter for 3-phase Eurostandard Plus® track systems

Size

Ø 140mm

Luminaire luminous flux

1295–1315 lm

Connected wattage

14.8 W

Half beam angle

16°–58°

Colour temperature

3000 K · 4000 K

LED module

Colour rendering index

CRI > 90

Power supply unit

DALI controllable

Optical system

BEGA Hybrid Optics®

Material

Safety glass



Page 58



Page 198

Finish



Q P 0261

Size

Ø 90 · 120 · 135 mm

Luminaire luminous flux

840–3870 lm

Connected wattage

14.5–46.5 W

Half beam angle

24°–72°

Colour temperature

3000 K · 4000 K or
Tunable white 2700–6500 K

LED module

Colour rendering index

CRI > 80 · > 90

Power supply unit

DALI controllable

Optical system

BEGA Hybrid Optics®
BEGA Constant Optics®



Page 59



Page 199

BEGA Thermal Management®

Accessories

Optical diffuser filters

Material

Safety glass

Finish



Q P 0263



Infinitely adjustable
half beam angle

Size

Ø 90 · 120 mm

Luminaire luminous flux

495 – 1660 lm

Connected wattage

15.0 · 29.5 W

Half beam angle

einstellbar von 15°–50°

Colour temperature

3000 K · 4000 K

LED module

Colour rendering index

CRI >90

Power supply unit

DALI controllable

Accessories

Optical diffuser filters

Finish



Page 59

Zoom optics



Q P 0136



Size

□ 95 · 130 mm

Luminaire luminous flux

1600 – 3100 lm

Connected wattage

25.4 · 37.1 W

Colour temperature

3000 K · 4000 K

LED module

Colour rendering index

CRI >90

Power supply unit

DALI controllable

Material

Safety glass

Finish



Q P 0201



CEILING LUMINAIRES · LARGE-AREA LUMINAIRES

Unusual dimensions

Large-area ceiling luminaires with impressive light outputs and optical systems that exactly match our LED modules. These DIN EN 12464-1-compliant luminaires are particularly well suited for glare-free workplace illumination.

The optical system consists of micro-structured and light-directing reflection layers to ensure glare-free light and optimum visual comfort.

The square ceiling luminaires are available with fixed or variable colour temperature (tunable white).

Tunable white luminaires can be controlled using a DALI colour light control (DT8, TW). Colour temperatures can be set between 2,700 K and 6,000 K, which perfectly corresponds to the colour temperature range that is considered ideal.

By adjusting the colour temperature, the lighting can be adapted to your lighting requirements or the desired mood – for efficient work conditions in an optimized lighting atmosphere.

The series is available in two versions:

- 90 % direct and 10 % indirect light or
- 100 % direct light

This large-area luminaire is also available as pendant luminaire.

90 % direct, 10 % indirect light

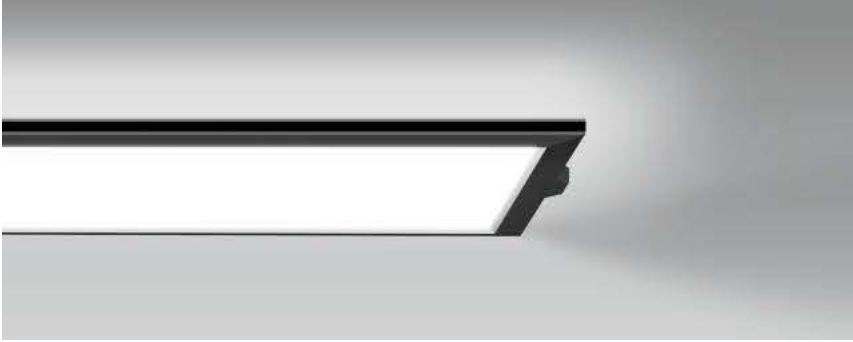

100 % direct light

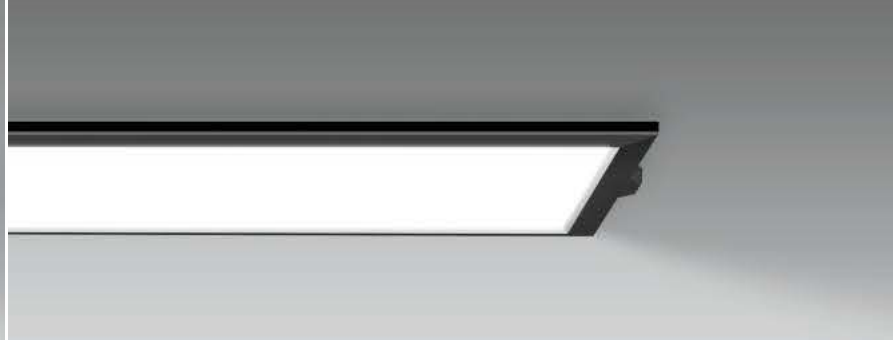



Ceiling luminaires · Large-area luminaires

Size

600 mm

Luminaire luminous flux

4310 · 5080 lm

Connected wattage

56.0 · 57.0 W

Colour temperature

3000 K · 4000 K or
Tunable white 2700–6000 K

LED module**Colour rendering index**

CRI > 90

Power supply unit

DALI controllable

BEGA Thermal Management®**Light-directing optical system**

consisting of micro-structured reflection layers
and safety glass

Finish

🔍 P 0152

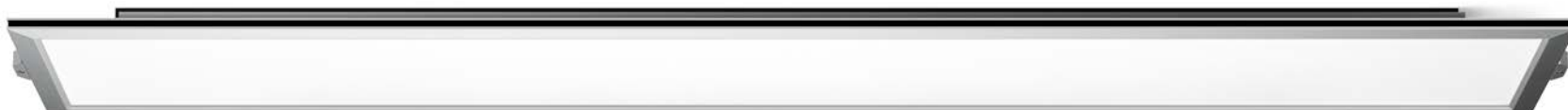

Extra flat ceiling luminaires Large-area luminaires

Size

345 x 1565 mm

Luminaire luminous flux

5960 · 6715 lm

Connected wattage

60.0 W

Colour temperature

3000 K · 4000 K

LED module**Colour rendering index**

CRI > 90

Power supply unit

DALI controllable

BEGA Thermal Management®**Light-directing optical system**

consisting of micro-structured reflection layers

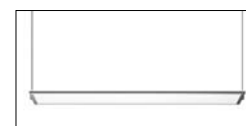
Finish

Page 239

Q P0194



Frame height 11 mm

STUDIO LINE CEILING LUMINAIRES

Ambiance and technology under one roof

The right mix makes all the difference: these STUDIO LINE ceiling luminaires combine efficient and lasting LED technology with a superb light ambiance. Light-directing reflectors are combined and rounded off with metallic attachments in various colours.

A fascinating mix of materials with a beautiful look – lit or unlit. Choose between the traditional sphere or a cylindrical shape. The spherical luminaires with asymmetrical light distribution are particularly well suited to illuminate wall surfaces. They can be rotated 360 degrees on the vertical luminaire axis to direct the light exactly where it is wanted.

STUDIO LINE finishes

Velvet white or velvet black outside colour

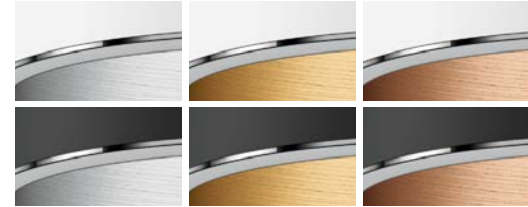

Inside colour
Matt aluminium

Inside colour
Matt brass

Inside colour
Matt copper





Technology and ambiance: this fascinating material mix looks just as good when lit or unlit.



Custom-made STUDIO LINE ceiling luminaires with velvet black trim ring



STUDIO LINE
Ceiling luminaires

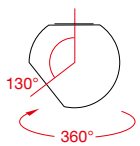

Page 208



Page 259

Size
Ø 140 · 190 mm

Luminaire luminous flux
775–1220 lm

Connected wattage
10.0–13.5 W

Half beam angle
24°–39°

Colour temperature
3000 K

LED module

Colour rendering index
CRI > 90

Power supply unit
DALI controllable

BEGA Thermal Management®

Outside colour



Inside colour



Q P0105



Page 209

Size
Ø 90 · 120 · 135 · 180 mm

Luminaire luminous flux
325–1860 lm

Connected wattage
5.0–19.5 W

Half beam angle
24°–43°

Colour temperature
3000 K

LED module

Colour rendering index
CRI > 90

Power supply unit
on/off · DALI controllable

BEGA Thermal Management®

Outside colour



Inside colour



Q P0104



STUDIO LINE CEILING LUMINAIRES

Cylindrical or cuboid-shaped ceiling luminaires

Ceiling luminaires with shielded light – small, compact luminaires for applications where the aim is to create islands of light.

Arranged in rows, they are a great solution for the glare-free illumination of corridors and hallways.

They are part of the STUDIO LINE series and feature economical and reliable LED

technology as well as a fascinating mix of materials.

These timeless ceiling luminaires with metallic inside colour hues display their full beauty when lit.

Choose from six colour combinations to match your interior theme.



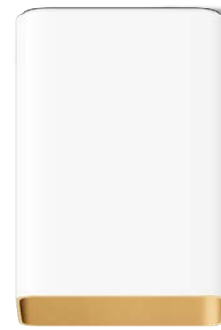
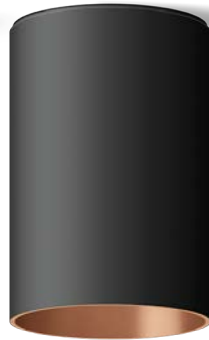

Size
Ø 80 · 100 mm

Luminaire luminous flux
310 · 445 lm

Connected wattage
6.0 · 10.6 W

Colour temperature
3000 K

LED module

Colour rendering index
CRI > 90

Power supply unit
on/off

Outside colour



Inside colour



Q P0274



Page 53



Page 173



Page 173

Size
□ 85 · 105 mm

Luminaire luminous flux
235 · 380 lm

Connected wattage
6.0 · 10.6 W

Colour temperature
3000 K

LED module

Colour rendering index
CRI > 90

Power supply unit
on/off

Outside colour



Inside colour



Q P0113



Page 53



Page 172



STUDIO LINE CEILING LUMINAIRES

The light effect that makes all the difference

These two product lines from the STUDIO LINE series are close to identical in terms of sizes and technical values – their only difference lies in the height of their outer metal shields. The higher metal shield ensures that the light is fully shielded on the sides. The version with the lower metal shield allows the light to also be emitted laterally into the room.

Choose your luminaires to create the lighting atmosphere you want for the illuminated interior space. This allows you to decide whether you want more or less vertical illuminance.

Both versions come with our high-quality LED modules or with a E 27 screw base – including the matching LED lamps.



Q P0140

Q P0222



STUDIO LINE
Ceiling luminaires



Page 53



Page 81



Page 221



Page 229

Size
Ø 260 · 360 · 430 mm

Luminaire luminous flux
730–4270 lm

Connected wattage
12.0–47.1 W

Colour temperature
3000K

LED
LED module

Lamp
E 27 LED lamp included

Colour rendering index
CRI > 80 · > 90

Power supply unit
on/off · DALI controllable

BEGA Thermal Management®

Material
White, translucent
synthetic cover

Outside colour



Inside colour



🔍 P 0140



Page 227

Size
Ø 260 · 360 · 430 mm

Luminaire luminous flux
785 – 4465 lm

Connected wattage
12.0 – 47.1 W

Colour temperature
3000 K

LED
LED module

Lamp
E 27 LED lamp included

Colour rendering index
CRI > 80 · > 90

Power supply unit
on/off · DALI controllable

BEGA Thermal Management®

Material
White, translucent
synthetic cover

Outside colour



Inside colour



Q P 0222



STUDIO LINE CEILING LUMINAIRES · LARGE-AREA LUMINAIRES

Light with impressive dimensions

Impressive luminaires of the STUDIO LINE series for large area ceiling illumination: high-quality materials and technology, paired with unusually high light output. We recommend these durable and economical lighting tools for sophisticated interior spaces.

The luminaires are – of course – DALI controllable and available with variable colour temperature (tunable white: 2700 to 6500 Kelvin).

That means they can be adjusted individually to your lighting situation or the desired mood for the interior space.

STUDIO LINE finishes

Velvet white or velvet black outside colour



White



Matt aluminium



Matt brass



Matt copper

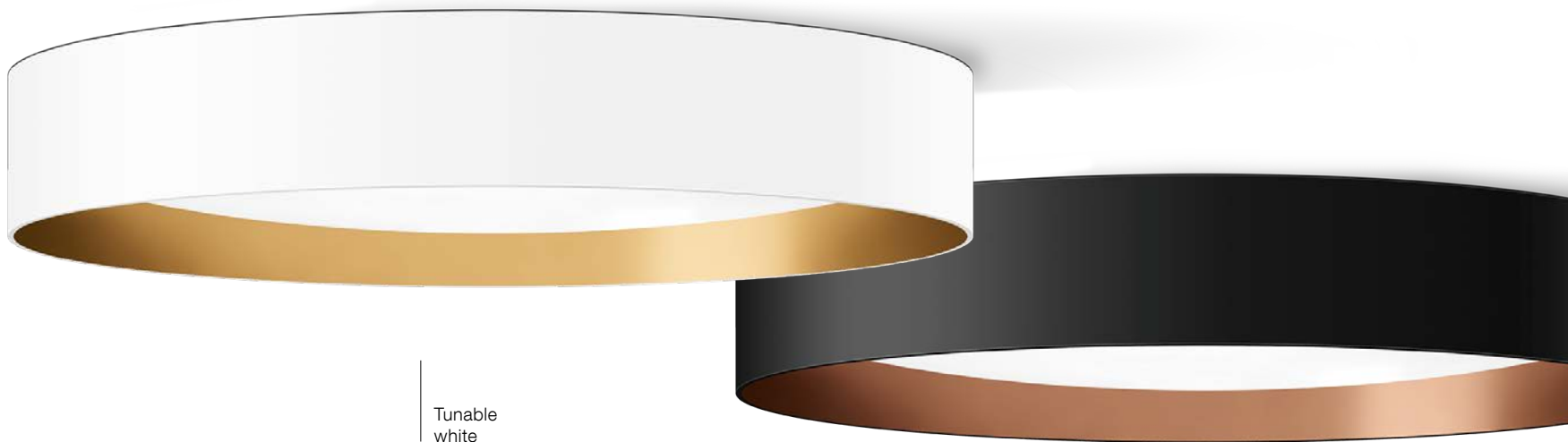

Tunable
white



Page 229

Size

Ø 1000 · 1300 mm

Luminaire luminous flux

10 470 – 16 200 lm

Connected wattage

101.0 – 144.0 W

Colour temperature

3000 K or
Tunable white 2700 – 6500 K

LED module

Colour rendering index
CRI > 90

Power supply unit

DALI controllable

BEGA Thermal Management®

Material

White, translucent
synthetic cover

Outside colour



Inside colour



Q P0199



PRIMA CEILING AND WALL LUMINAIRES

Economical and versatile

The luminaires of the PRIMA series are designed for applications that primarily require reliable technology and high cost efficiency. Attractive investment costs and exemplary lighting values are just as much part of the performance characteristics of this model series, as is the BEGA LED technology including all of its warranty promises. The luminaires come with hand-blown, satin matt opal glass or with an impact-resistant, translucent synthetic cover. Add-on trim rings in a variety of colours will allow you to match the luminaires to your overall interior style.

The economic reliability of the luminaires is made additionally attractive due to a host of interesting add-on functions. Choose between luminaires with on/off or DALI controllable power supply units and utilise the advantages of integrated motion sensors and single emergency lighting batteries. The ability to choose between two outputs for each luminaire size allows you to directly influence the number of luminaires used, their light effect and their impact on the interior design theme as early as the planning stage.



Motion sensor

- High frequency technology
- Range of 10m, conical detection field of approx. 120°
- Various setting options

Single emergency lighting battery

- Emergency lighting function as per EN 60598-2-22 and DIN VDE 0108-100
- Emergency lighting operation for three hours in case of a power outage
- Battery service life: four years

Trim rings/frames

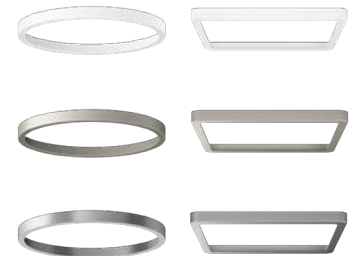

**Size**

Ø 325 · 410 · 480 mm

Luminaire luminous flux

785–4750 lm

Connected wattage

10.3 · 48.8 W

Colour temperature

2700 K · 3000 K

LED module**Colour rendering index**

CRI >90

Power supply unit

on/off · DALI controllable

BEGA Thermal Management®**Optional add-on functions**

Motion sensor

Single emergency lighting battery

Material

Opal glass

Q P 0234



Optional
trim ring

Size

Ø 250 · 350 · 420 mm

Luminaire luminous flux

710–4850 lm

Connected wattage

10.3 · 48.8 W

Colour temperature

2700 K · 3000 K

LED module**Colour rendering index**

CRI >90

Power supply unit

on/off · DALI controllable

BEGA Thermal Management®**Optional add-on functions**

Motion sensor

Single emergency lighting battery

Material

Opal glass

Impact-resistant, white, translucent synthetic cover

Ceiling trim ring finish

Q P 0269



Optional
trim ring

Size

Ø 250 · 350 · 420 mm

Luminaire luminous flux

670–5070 lm

Connected wattage

10.3 · 48.8 W

Colour temperature

2700 K · 3000 K

LED module

Colour rendering index

CRI > 90

Power supply unit

on/off · DALI controllable

BEGA Thermal Management®

Optional add-on functions

Motion sensor

Single emergency lighting battery

Material

Three-ply opal glass

Impact-resistant, white, translucent synthetic cover

Ceiling trim ring finish



Q P 0252



Optional
trim frame

Size

□ 240 · 320 mm

Luminaire luminous flux

955–3145 lm

Connected wattage

9.5–27.7 W

Colour temperature

2700 K · 3000 K

LED module

Colour rendering index

CRI > 90

Power supply unit

on/off · DALI controllable

BEGA Thermal Management®

Optional add-on functions

Motion sensor

Material

Three-ply opal glass

Impact-resistant, white,

translucent synthetic cover

Ceiling trim frame finish



Q P 0167



CEILING AND WALL LUMINAIRES

Light Brick – Lichtbaustein® – the lighting classic

The Light Brick – Lichtbaustein® has been a BEGA trademark for more than 60 years. As a lighting classic, its timeless and understated design is a true evergreen.

All our luminaires of this kind come equipped with state-of-the-art lighting technology as a matter of course.

We have made some subtle changes to their design over the years. What has not changed is the fact that these luminaires come with an integrated LED module, and we also have

a model with screw base E 14 or E 27 – the matching LED lamps are also included in the scope of delivery.

Luminaires that are suitable for installation on ceilings and walls and that can be used for a multitude of lighting applications.

These luminaires have the protection class IP 44 and are VDE 0100-compliant, which makes them perfect for bathroom lighting.

Luminaires you can build with: individually, in rows or in groups.

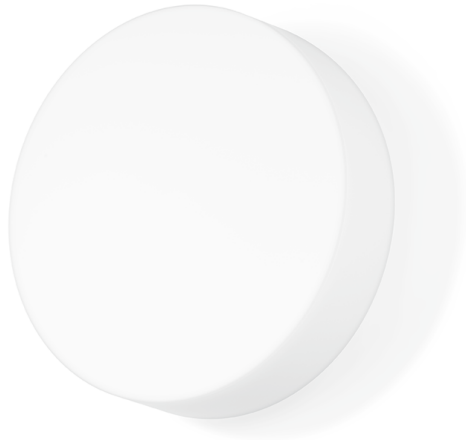

Protection class
IP 44

Size
Ø 160 · 220 · 300 · 350 · 390 mm

Luminaire luminous flux
330–4325 lm

Connected wattage
4.0–45.0 W

Colour temperature
2700 K · 3000 K

LED
LED module

Lamp
E 14/E 27 LED lamp included

Colour rendering index
CRI > 80 · > 90

Power supply unit
on/off · DALI controllable

BEGA Thermal Management®

Material
Three-ply opal glass

Q P 0278

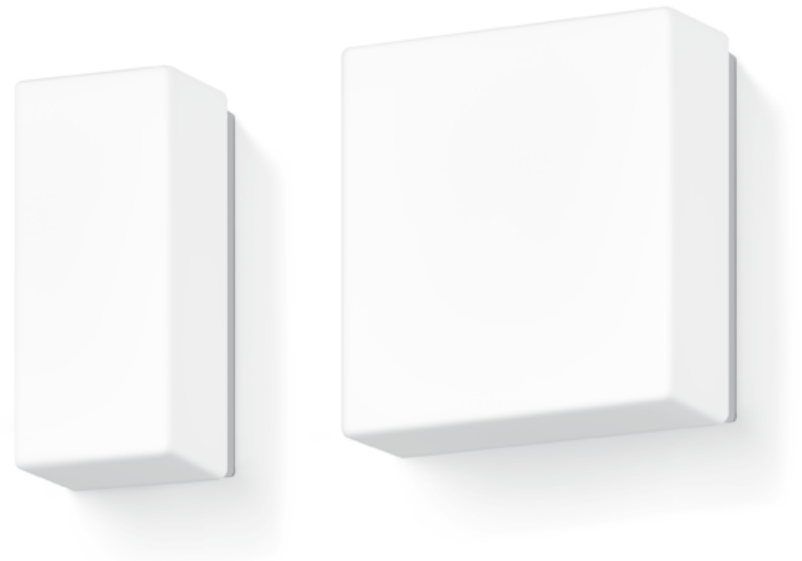

Protection class
IP 44

Height
□ 210 · 300 · 450 mm
□ 160 · 210 · 280 · 320 mm

Luminaire luminous flux
280–2990 lm

Connected wattage
4.0–30.6 W

Colour temperature
2700 K · 3000 K

LED
LED module · BEGA phase-dimmable AC module

Lamp
E 14/E 27 LED lamp included

Colour rendering index
CRI > 80 · > 90

Power supply unit
on/off · DALI controllable

BEGA Thermal Management®

Material
Three-ply opal glass

Q P 0187 · P 0123

CEILING AND WALL LUMINAIRES

A ring makes all the difference

Classic luminaires for interior spaces. Premium finish, reliable and designed for long operating times – extra versatile lighting tools for use in modern or historical architecture. Separate metal trim rings with a choice of four finishes can be added to the luminaires to match a variety of materials used in the interior design theme.

The hand-blown, three-ply opal glass with satin matt finish gives the luminaire its high-end look.

These luminaires have the protection class IP 44 and are VDE0100-compliant, which makes them perfect for bathroom lighting.

Trim rings



Colour white



Stainless steel finish



Chrome finish



Brass





Optional
trim ring



Protection class
IP 44

Ceiling and wall luminaires

Size
Ø 250 · 340 · 390 · 470 mm

Luminaire luminous flux
960–4765 lm

Connected wattage
14.0–64.5 W

Colour temperature
2700 K · 3000 K

LED
LED module

Lamp
E 27 LED lamp included

Colour rendering index
CRI >80 · >90

Power supply unit
DALI controllable

BEGA Thermal Management®

Material
Three-ply opal glass

Trim ring finish



Q P0131

Optional
trim ring



Protection class
IP 44

Size
Ø 220 · 255 · 300 · 350 · 400 mm

Luminaire luminous flux
490–4200 lm

Connected wattage
7.0–45.0 W

Colour temperature
2700 K · 3000 K

LED
LED module

Lamp
E 27 LED lamp included

Colour rendering index
CRI >80 · >90

Power supply unit
on/off · DALI controllable

BEGA Thermal Management®

Material
Three-ply opal glass

Trim ring finish



Q P 0238



CEILING AND WALL LUMINAIRES

Unshielded or shielded

Unshielded or laterally shielded luminaires for ceiling or wall installation. Set in rows, these luminaires are the perfect choice for corridors, hallways and stairwells.

Choose between unshielded luminaires, which illuminate their surroundings and the installation surface softly and uniformly, and the shielded version, which does not illuminate the walls in its immediate vicinity.

The laterally shielded version allows a small portion of the light to be emitted onto the installation surface, which gives the luminaires a floating appearance.

We optionally offer both versions with hand-blown opal glass or an impact-resistant, translucent synthetic cover.





Protection class
IP 44



Size
Ø 340 · 390 · 470 mm

Luminaire luminous flux
810–3845 lm

Connected wattage
14.0–35.0 W

Colour temperature
2700 K · 3000 K

LED
LED module

Lamp
E 27 LED lamp included

Colour rendering index
CRI >80 · >90

Q P 0248



Protection class
IP 44



Size
Ø 360 · 420 · 500 mm

Luminaire luminous flux
650–3515 lm

Connected wattage
14.0–35.0 W

Colour temperature
2700 K · 3000 K

LED
LED module

Lamp
E 27 LED lamp included

Colour rendering index
CRI >80 · >90

Q P 0207

Power supply unit
on/off · DALI controllable

BEGA Thermal Management®

Material
Three-ply opal glass
Impact-resistant, white, translucent
synthetic cover

Metal shield finish





CEILING AND WALL LUMINAIRES

Highest glassmaking craftsmanship

The luminaire glass of these unshielded ceiling and wall luminaires are impressive examples of glassmaking art. Traditional craftsmanship meets cost-effective and durable technology. These luminaires in various sizes and light outputs offer a wide range of planning options. Their optional use for ceiling or wall installation

and the combination with matching pendant luminaires significantly broaden their possible area of application.

We also offer luminaires with impact-resistant, translucent synthetic covers for applications in which glass cannot be used.



Size
Ø 400 · 460 · 560 mm

Luminaire luminous flux
955 – 3600 lm

Connected wattage
10.0 – 35.0 W

Colour temperature
3000 K

LED module

Colour rendering index
CRI > 90

Power supply unit
on/off · DALI controllable

BEGA Thermal Management®

Material
Three-ply opal glass



Page 191

Size
Ø 350 · 420 · 510 mm

Luminaire luminous flux
940 – 4200 lm

Connected wattage
10.0 – 35.0 W

Colour temperature
3000 K

LED module

Colour rendering index
CRI > 90

Power supply unit
on/off · DALI controllable

BEGA Thermal Management®

Material
Three-ply opal glass
Impact-resistant, white, translucent
synthetic cover



Page 191

Q P0244

Q P0156

CEILING AND WALL LUMINAIRES

Perfectly shaped glass

A selection of ceiling and wall luminaires in various sizes and light outputs.

Luminaires for areas that require high-end components with economical technology for the low-maintenance illumination of stairwells, corridors and interior spaces. In addition to the thick-walled crystal glass – with a

captivating clarity in its shape, brilliant in the transmission of light – these luminaires are also available with satin matt three-ply opal glass. They create a highly attractive feature, whether as single luminaires or arranged in groups. Luminaires that have the required protection class according to VDE 0100 come with IP 64 or IP 65 labelling.

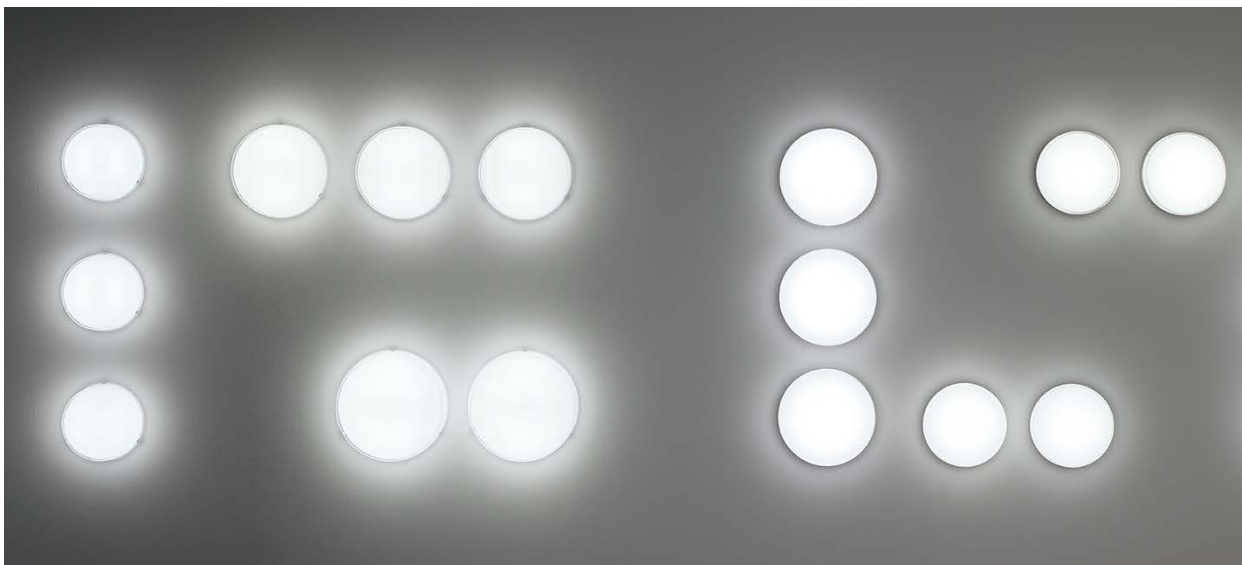





Protection class
IP 64

Ceiling and wall luminaires

Size
Ø 260 · 305 mm

Luminaire luminous flux
985 – 1940 lm

Connected wattage
16.0 – 22.5 W

Colour temperature
3000 K

LED module

Colour rendering index
RI > 90

Power supply unit
on/off · DALI controllable

BEGA Thermal Management®

Material
Three-ply opal glass
Crystal opal glass

Finish



Q P 0259



Protection class
IP 65



Size
Ø 160 · 210 · 260 mm

Luminaire luminous flux
365–1415 lm

Connected wattage
5.8–18.0 W

Colour temperature
3000 K

LED module

Colour rendering index
CRI > 90

Power supply unit
on/off · DALI controllable

BEGA Thermal Management®

Material
Crystal glass, inside white

Finish



Q P 0210

Size
Ø 200 · 250 · 300 · 350 mm

Luminaire luminous flux
500–2285 lm

Connected wattage
7.4–27.2 W

Colour temperature
3000 K

LED
LED module · BEGA AC module

Colour rendering index
CRI > 90

Power supply unit
on/off · DALI controllable

BEGA Thermal Management®

Material
Crystal glass, inside white

Q P 0227



Large-area luminaires offer one particular advantage: their high light output is distributed across a larger light aperture and therefore creates a softer light, which is distributed uniformly in the room. This enables a very high light output without glare.

CEILING AND WALL LUMINAIRES · LARGE-AREA LUMINAIRES

Large-scale lighting

Two luminaire series that open up entirely new and creative design options for many interior applications due to their large size. Large-area LED lighting with exceptionally high light outputs and impressive diameters – particularly fascinating when arranged in groups.

The luminaires are DALI controllable and available with either fixed or variable colour temperature (tunable white). Tunable white-controllable luminaires can be set to colour temperatures between 2700 and 6500 Kelvin.

Such variability in colour temperature allows adaptations to any desired lighting requirements.





PLANETA

Ceiling and wall luminaires

Size
Ø 500 · 750 mm

Luminaire luminous flux
6150 · 10270 lm

Connected wattage
76.4 · 118.0 W

Colour temperature
3000 K

LED module

Colour rendering index
CRI > 90

Power supply unit
DALI controllable

BEGA Thermal Management®

Material
Safety glass, inside white

Finish



Q P0181



Page 232

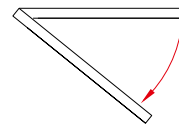



Tunable
white

MAXIMA

Ceiling and wall luminaires

Size

Ø 1000 · 1300 mm

Luminaire luminous flux

12 365 – 17 295 lm

Connected wattage

101.0 – 144.0 W

Colour temperature

3000 K or
Tunable white 2700 – 6500 K

LED module

Colour rendering index

CRI > 90

Power supply unit

DALI controllable

BEGA Thermal Management®

Material

White, translucent synthetic cover

Q P0277



Page 233





CEILING AND WALL LUMINAIRES

Linear light

Dots, lines and areas are not just basic design elements in art – they also form the basics of architecture and lighting design.

Both luminaire series can be used for linear enhancements to emphasise architectural structures or as single luminaires to create light accents.

LED technology and our in-house LED module production allow us to break new ground in luminaire design and develop distinctive luminaires with unique dimensions.

Such unusual design lengths open up new, exhilarating options in many areas of interior design.



Ceiling and wall luminaires

Length

1050 · 1550 · 2050 mm

Luminaire luminous flux

4355–8980 lm

Connected wattage

42.0–80.0 W

Colour temperature

3000 K

LED module**Colour rendering index**

CRI >90

Power supply unit

DALI controllable

BEGA Thermal Management®

Material

White, translucent
synthetic cover

Finish

Q P 0204



LINEARA

Ceiling and wall luminaires

Length

610 · 1010 · 1510 · 2010 mm

Luminaire luminous flux

2650–9425 lm

Connected wattage

26.6–80.0 W

Colour temperature

3000 K

LED module**Colour rendering index**

CRI >90

Power supply unit

DALI controllable

BEGA Thermal Management®

Material

White, translucent
synthetic cover

Finish

Page 237

Q P 0235







ACCENTA RECESSED WALL LUMINAIRES

Compact illumination from within the wall

Small and compact luminaires with high-end LED technology for many applications in interior design. These recessed luminaires of the ACCENTA series are true all-rounders.

They help highlight dangerous areas and illuminate stairs, corridors and hallways at a low mounting height.

They develop their true potential as on-wall light installations.

The installation is done quickly and easily in standard cavity wall boxes with 68-millimetre diameter.

Each luminaire comes with a matching cavity wall box.

The small luminaires do not just get points for technology and quality – they also offer plenty of diversity in terms of light effect and material characteristics.



ACCENTA recessed wall luminaires for installation in cavity wall boxes



Shielded light

Unshielded light





ACCENTA

Recessed wall luminaires



Size
Ø 75 mm

Recessed opening
68 mm

Luminaire luminous flux
50 · 100 lm

Connected wattage
2.1 · 3.0 W

Colour temperature
2700 K · 3000 K

LED module

Colour rendering index
CRI > 90

Power supply unit
on/off

Material
Safety glass, inside white

Finish



Q P 0133

Size
Ø 75 mm

Recessed opening
68 mm

Luminaire luminous flux
40 – 185 lm

Connected wattage
2.1 · 3.0 W

Colour temperature
2700 K · 3000 K

LED module

Colour rendering index
CRI > 90

Power supply unit
on/off

Material
Safety glass, inside white

Finish



Q P 0106 · P 0280



Size
□ 75 mm

Recessed opening
68 mm

Luminaire luminous flux
50 · 90 lm

Connected wattage
2.1 · 3.0 W

Colour temperature
2700 K · 3000 K

LED module

Colour rendering index
CRI > 90

Power supply unit
on/off

Material
Safety glass, inside white

Finish



Q P 0281



Size
□ 75 mm

Recessed opening
68 mm

Luminaire luminous flux
50 · 85 lm

Connected wattage
2.1 · 3.0 W

Colour temperature
2700 K · 3000 K

LED module

Colour rendering index
CRI > 90

Power supply unit
on/off

Material
Safety glass, inside white

Finish



Q P 0186

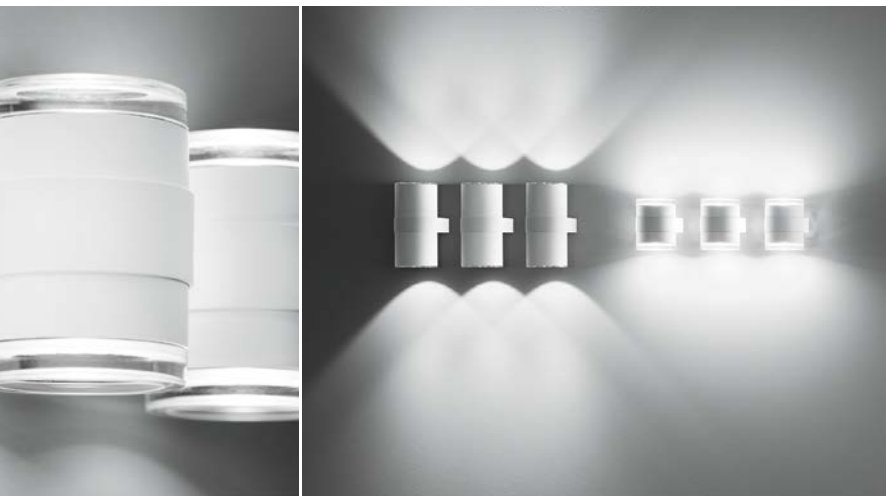

WALL LUMINAIRES

Light emission on two sides

Wall luminaires that emit their light upward and downward are particularly well suited for the efficient and striking illumination of walls, pillars and other architectural details. Luminaires with reflector technology that highlight architectural features with light characteristics similar to those of floodlights or with two thick-walled crystal glass layers that create a fascinating and brilliant illumination in addition to the reflector-directed light.



Size
Ø 120 · 135 mm

Luminaire luminous flux
1775 · 2555 lm

Connected wattage
19.3 · 26.3 W

Colour temperature
3000 K · 4000 K

LED module

Colour rendering index
CRI > 90

Power supply unit
DALI controllable

BEGA Thermal Management®

Material
Partially frosted crystal glass

Finish



Q P0218



Page 177



Size
Ø 120 · 135 mm

Luminaire luminous flux
1805 · 2520 lm

Connected wattage
19.3 · 26.3 W

Half beam angle
39° · 40°

Colour temperature
3000 K · 4000 K

LED module

Colour rendering index
CRI > 90

Power supply unit
DALI controllable

BEGA Thermal Management®

Material
Safety glass

Finish



Q P0245



Page 199

WALL WASHERS

Light for walls and ceilings

Wall washers are luminaires that emit their light at a high output rate onto the surfaces to be illuminated.

Integrated reflectors or reflector systems provide more precise light direction compared to unshielded luminaires.

Wall washers with a trapezoidal geometry can be optionally deployed with symmetrical or asymmetrical light distribution. The choice depends on whether they are intended to direct their light primarily onto the mounting

surface or into the room itself – for example for the illumination of ceiling or ground surfaces. These luminaires can be installed with their light emission pointing upward or downward.

The luminaires with rectangular geometry distribute their light evenly upward and downward. Their reflector system directs the light like a curtain across the mounting surface.



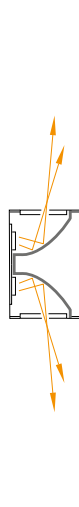

Width
250 · 320 mm

Luminaire luminous flux
2570 · 3845 lm

Connected wattage
28.4 · 38.2 W

Colour temperature
3000 K · 4000 K

LED module

Colour rendering index
CRI > 90

Power supply unit
on/off · DALI controllable

BEGA Thermal Management®

Finish

□ ■ ■

Q P0128



Width
200 · 260 · 320 mm

Luminaire luminous flux
1080 – 4165 lm

Connected wattage
12.5 – 36.1 W

Colour temperature
2700 K · 3000 K · 4000 K

LED module

Colour rendering index
CRI > 90

Power supply unit
on/off · DALI controllable

BEGA Thermal Management®

Finish

□ ■

Q P0172





Tunable
white

WALL LUMINAIRES WITH LIGHT EMISSION ON TWO SIDES

High light output in linear form

A luminaire series that lends itself for many application options in interior design based on their lighting technology, the range of light outputs and four model lengths between 615 and 1515 millimetres.

Specifically the longer models in this series create entirely new design options.

All luminaires are completely shielded and distribute their light uniformly upward and downward on the mounting surface.

The luminaires are DALI controllable and available with either fixed or variable colour temperature (tunable white). Tunable white-controllable luminaires can be set to colour temperatures between 2700 and 6500 Kelvin. They cover the colour temperature range that is perceived as ideal for the human eye. By freely choosing the colour temperature you can adjust the light colour to your desired lighting atmosphere.

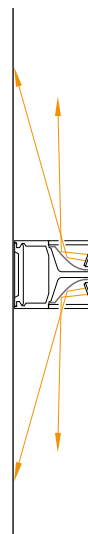

Length

615 · 915 · 1215 · 1515 mm

Luminaire luminous flux

3165 – 15 595 lm

Connected wattage

26.8 – 130.0 W

Colour temperature

3000 K or
Tunable white 2700 – 6500 K

LED module

Colour rendering index

CRI > 90

Power supply unit

DALI controllable

BEGA Thermal Management®

Material

Synthetic material
with light-diffusing texture

Finish



Q P 0149

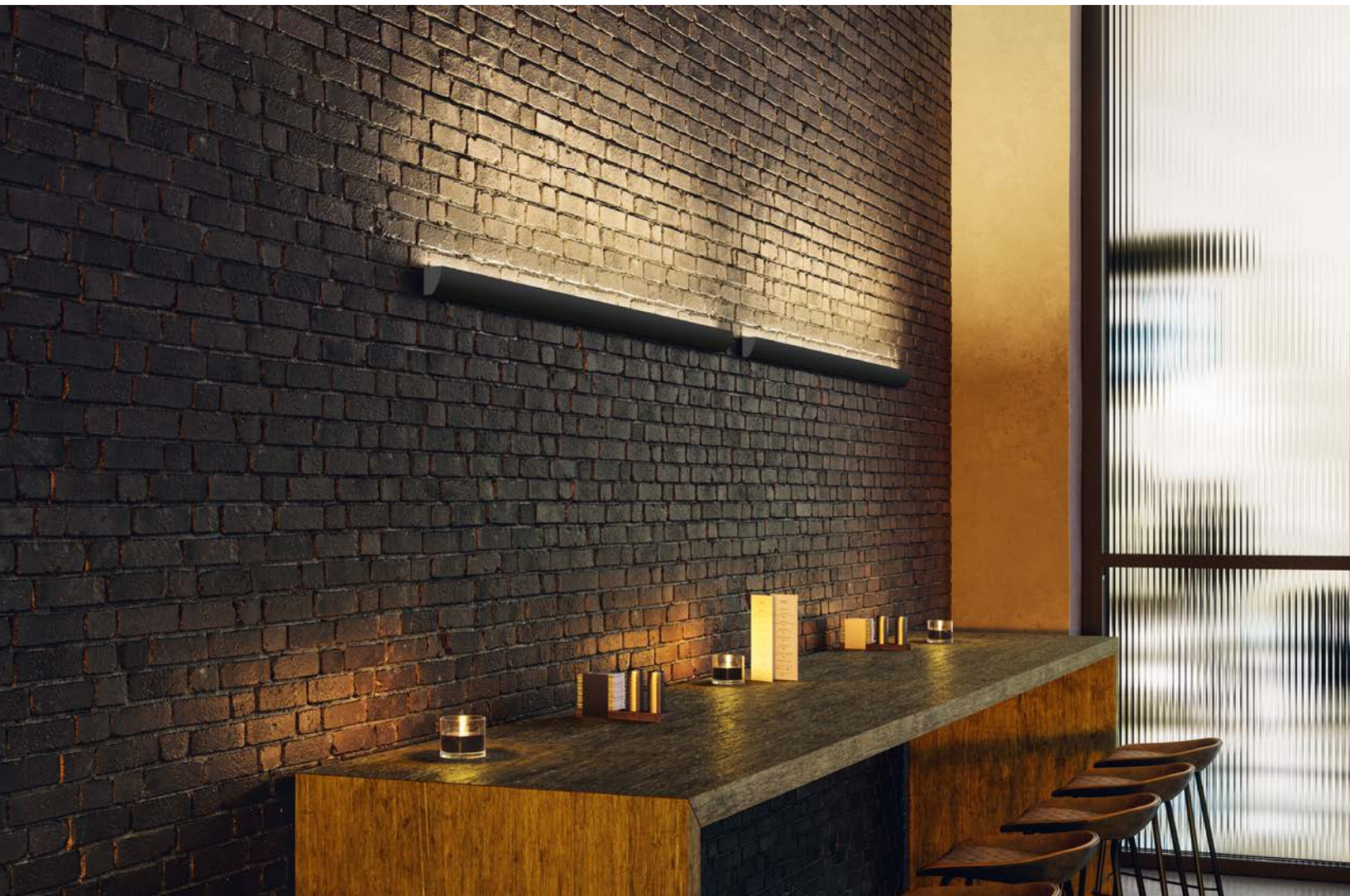

WALL LUMINAIRES

Ambiance and lighting technology

Two new wall luminaires that emit their light in one or two directions.

Both luminaires are available in three lengths, three colour versions and various light outputs. The luminaires are shielded towards the front and distribute their light via a silicone diffuser embedded in the luminaire profile.

Arranged individually or in rows, these are luminaires that are particularly well suited for the illumination of walls and corridors due to their design lengths and small overhang. Both versions feature a high colour rendering index and come equipped with DALI controllable power supply units.





Light emission on one side

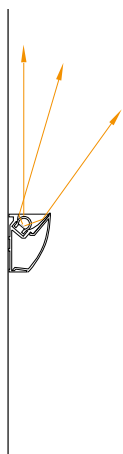

Length
740 · 1140 · 1840 mm

Luminaire luminous flux
960–3535 lm

Connected wattage
15.4–39.5 W

Colour temperature
3000 K

LED module

Colour rendering index
CRI >90

Power supply unit
DALI controllable

BEGA Thermal Management®

Material
Silicone light diffuser

Finish



Q P0110

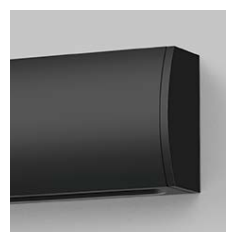

Light emission on two sides



Length
740 · 1140 · 1840 mm

Luminaire luminous flux
1920–7070 lm

Connected wattage
30.8–79.0 W

Colour temperature
3000 K

LED module

Colour rendering index
CRI >90

Power supply unit
DALI controllable

BEGA Thermal Management®

Material
Silicone light diffuser

Finish



Q P0151

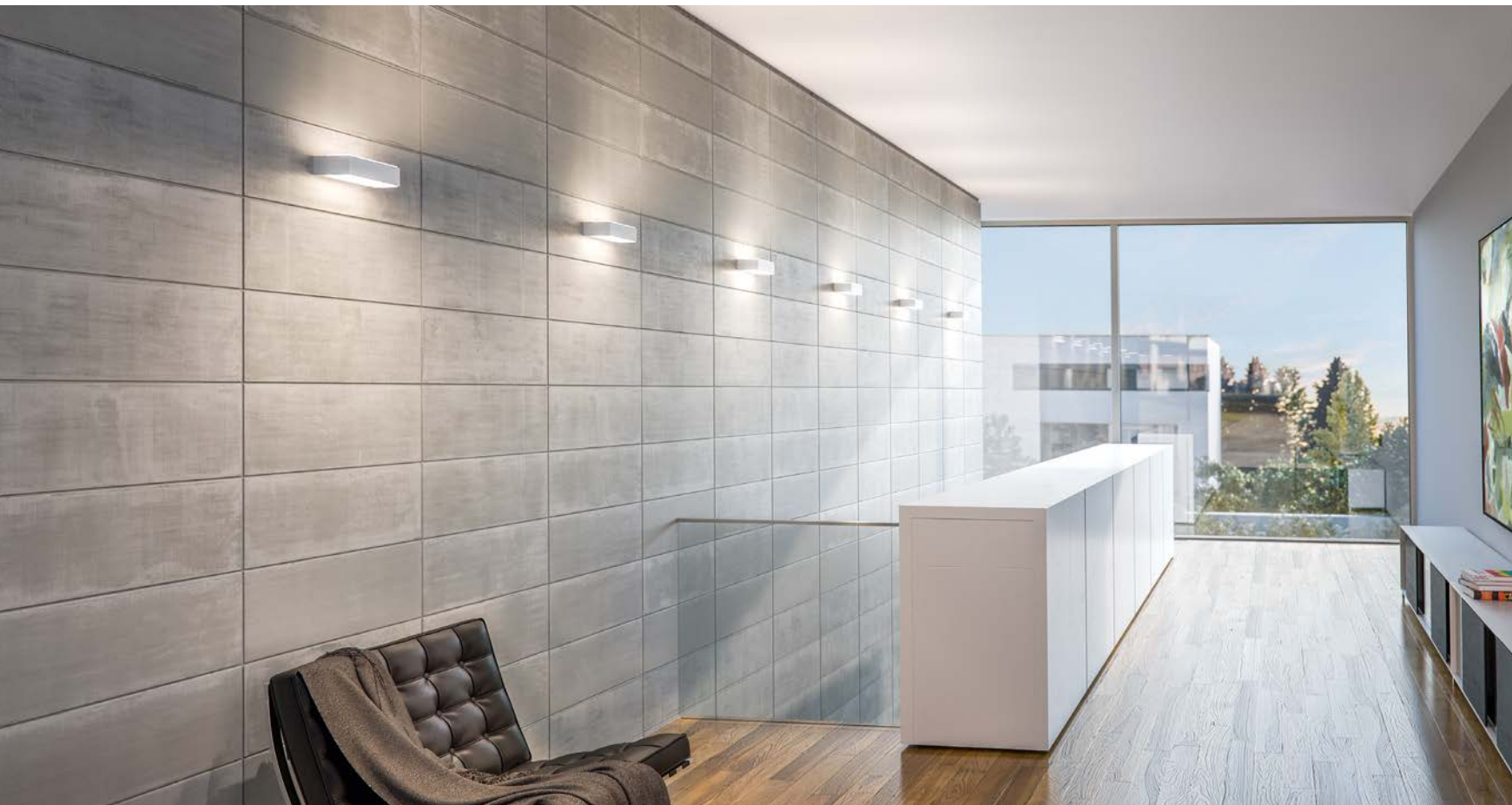

WALL LUMINAIRES

Bidirectional light

Wall luminaires that distribute their light upward and downward on the wall surface – for the illumination of walls and stairwell exits and for the staging of many other areas in interior design.

Two pieces of crystal glass with brilliantly polished edges give the luminaires their distinctive character. Straight-lined or curved – both versions meet the requirements of contemporary architectural details.



**Width**

200 · 300 mm

Luminaire luminous flux

675 · 1020 lm

Connected wattage

10.5 · 15.4 W

Colour temperature

3000 K

LED module**Colour rendering index**

CRI > 90

Power supply unit

on/off

BEGA Thermal Management®**Material**

Crystal glass, inside white

Finish

Q P0107

**Width**

200 · 300 mm

Luminaire luminous flux

445 · 785 lm

Connected wattage

10.5 · 15.4 W

Colour temperature

3000 K

LED module**Colour rendering index**

CRI > 90

Power supply unit

on/off

BEGA Thermal Management®**Material**

Crystal glass, inside white

Finish

Q P0247

PRIMA WALL LUMINAIRES

Unshielded or shielded

Luminaires of the PRIMA series are designed for applications that require reliable technology and high cost efficiency. Luminaires for universal use. Compact, economical and versatile – with durable LED technology. Unshielded or with metal shields in various finishes and glare suppression towards the front. Wall luminaires with hand-blown opal glass, which convince through their pleasant light. Individually or in groups, the high-contrast effect of these luminaires is ideal for interior design with atmospheric light.

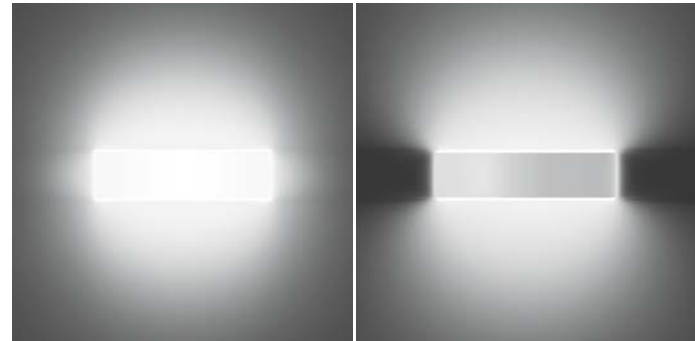

Unshielded

Shielded





Width
250 · 350 mm

Luminaire luminous flux
750 · 1610 lm

Connected wattage
10.0 · 20.0 W

Colour temperature
3000 K

Colour rendering index
CRI > 90

LED
BEGA AC module

BEGA Thermal Management®

Material
Three-ply opal glass

Q P0138



Width
255 · 355 mm

Luminaire luminous flux
495 · 1190 lm

Connected wattage
10.0 · 20.0 W

Colour temperature
3000 K

Colour rendering index
CRI > 90

LED
BEGA AC module

BEGA Thermal Management®

Material
Three-ply opal glass

Metal shield finish



Q P0139



WALL LUMINAIRES

To the point

Small, compact and amazingly versatile in terms of the range of lighting applications: luminaires that serve as subtle, yet high-end architectural details. Their very low-profile luminaire housings of only 55 millimetres make them particularly well suited for the illumination of corridors, hallways and many situations in stairway systems. Lit or unlit, these light sources look great when arranged as single luminaires or in rows.

The high-precision luminaire design is characterised by crystal glass with brilliantly polished edges to match the needs of modern architectural features.

Choose between luminaires with a square or rectangular shape and luminaires that emit their light in one or two directions – according to the requirements of your lighting situation.



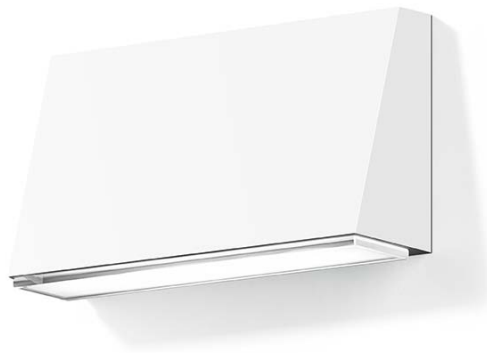

Width
90 · 175 mm

Luminaire luminous flux
225 – 765 lm

Connected wattage
2.7 – 7.2 W

Colour temperature
3000 K

LED module

Colour rendering index
CRI >90

Power supply unit
on/off

BEGA Thermal Management®

Material
Crystal glass, inside white

Finish

🔍 P 0223

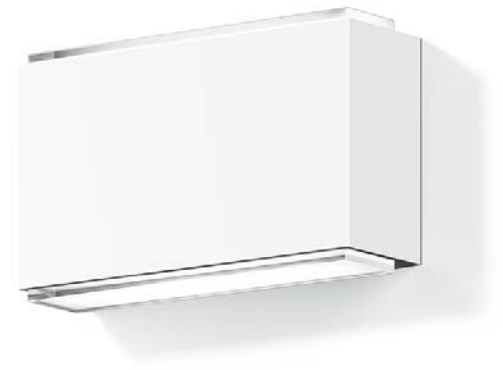

Width
90 · 175 mm

Luminaire luminous flux
260 – 880 lm

Connected wattage
5.2 – 14.8 W

Colour temperature
3000 K

LED module

Colour rendering index
CRI >90

Power supply unit
on/off

BEGA Thermal Management®

Material
Crystal glass, inside white

Finish

🔍 P 0246



WALL LUMINAIRES

Glass in its clearest form

Cube and sphere: two classic design elements that make excellent indoor illumination bodies. Both luminaires feature hand-blown luminaire glass with a memorable play on light as well as a sophisticated combination of glass and a metal corpus.

The cube with its thick-walled crystal glass sections is a valuable design detail – be lit or unlit.

The luminaires that feature white crystal on the inside create a multi-dimensional light effect, while the ice crystal glass separates the light of the LED into individual, small points of light to create a brilliant and faceted light image.



Size

□ 90 · 120 mm

Luminaire luminous flux

540 · 1175 lm

Connected wattage

9.0 · 19.3 W

Colour temperature

3000 K · 4000 K

LED module

Colour rendering index

CRI >90

Power supply unit

on/off · DALI controllable

BEGA Thermal Management®

Material

Crystal glass, inside white

Finish



Q P0163



Page 36



Page 66

Size
Ø 140 mm

Luminaire luminous flux
925 · 1275 lm

Connected wattage
11.3 W

Colour temperature
3000 K

LED module

Colour rendering index
CRI > 90

Power supply unit
on/off

BEGA Thermal Management®

Material
Ice crystal glass
Crystal glass, inside white

Finish



Q P 0119

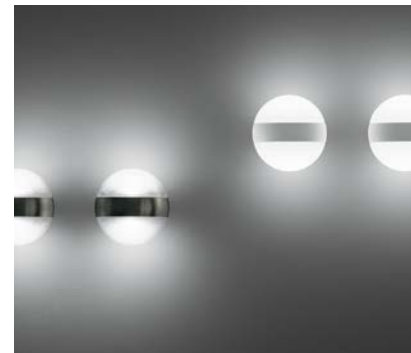



PEBBLES WALL LUMINAIRES
Inspired by nature

The Light Brick – Lichtbaustein® has been a BEGA trademark for more than 60 years. Circle, square or rectangle: that is how most people know this true evergreen among light features.

Our glass reaches a temperature of over 1300 degrees Celsius during processing. Our glassmakers install a translucent layer of opal glass between two layers of crystal glass. During that time, the glass has a viscosity like honey. We wanted to give this valuable glass

mass a new, more glass-like form – and got our inspiration from pebbles on the beach. Their soft, flowing and almost random shapes are very similar to those of glass during the melting process.

The luminaire glass moves freely on the fittings. That is how just two shapes in two sizes allow the creation of endless arrangements – reminiscent of the random, natural interplay of pebbles on the beach. And by far more beautiful with light.

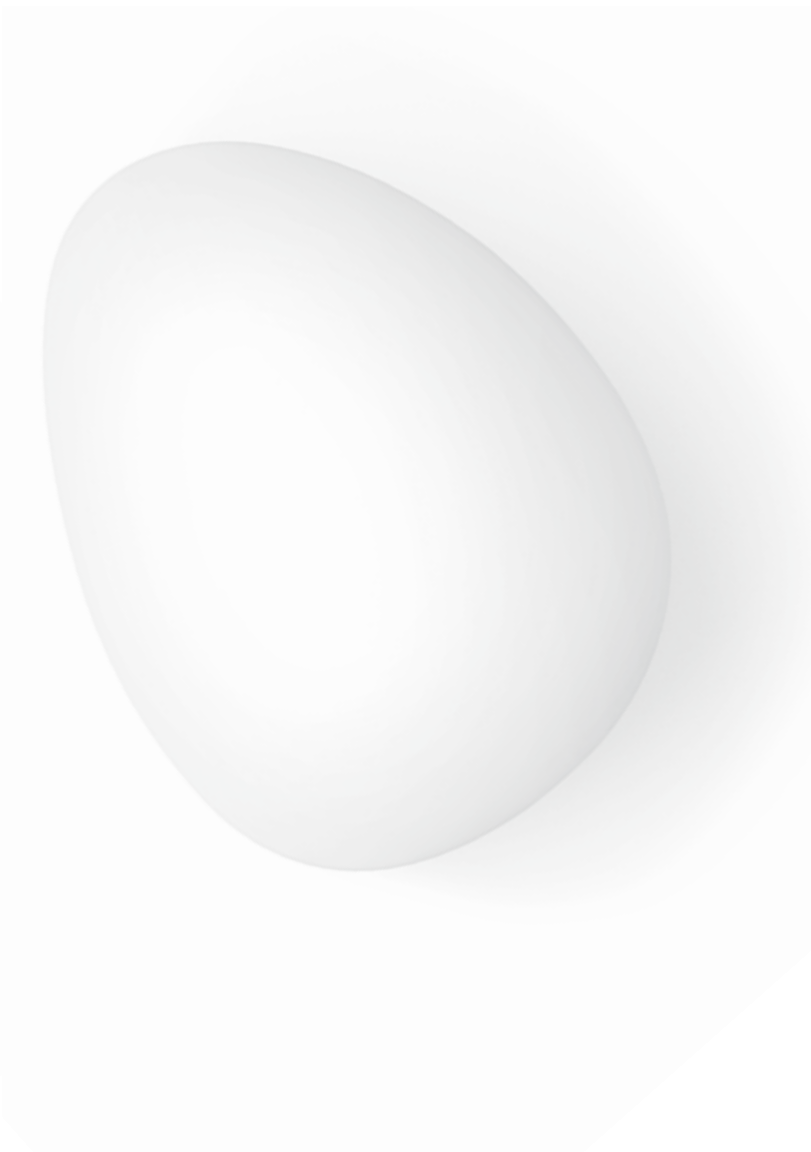
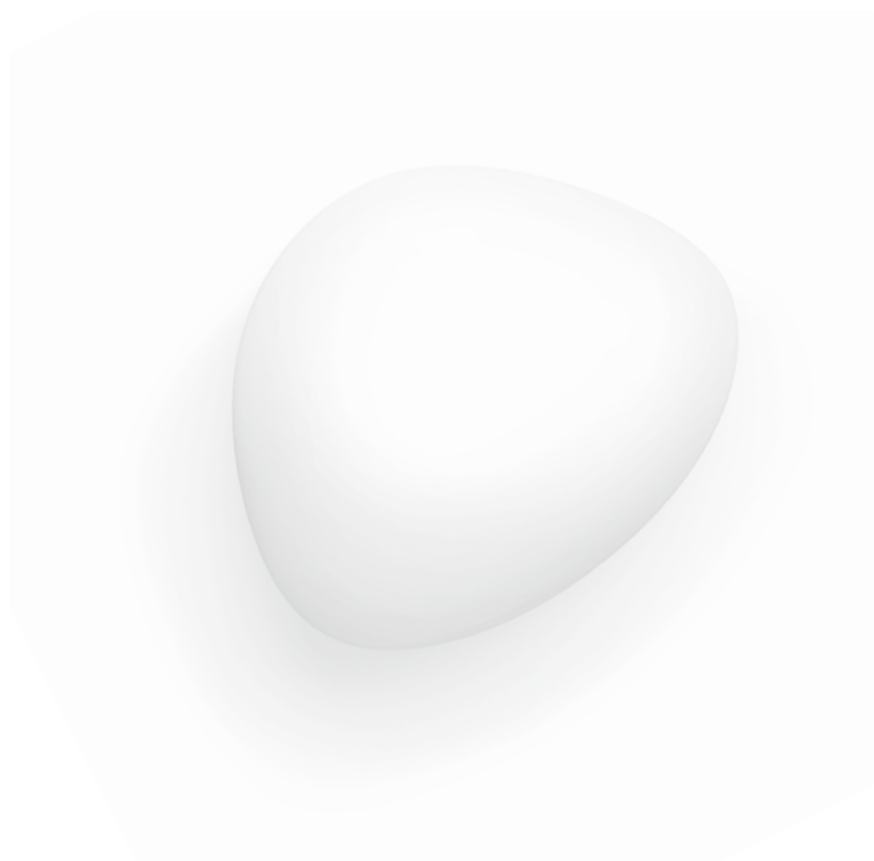

Fig. left

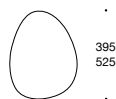

Fig. right

Size
355 · 395 · 470 · 525 mm

Luminaire luminous flux
950 · 2400 lm

Connected wattage
15.5 · 31.1 W

Colour temperature
2700 K · 3000 K

LED module

Colour rendering index
CRI > 90

Power supply unit
DALI controllable

BEGA Thermal Management®

Material
Three-ply opal glass

Q P 0251



WALL LUMINAIRES

To the point

These unshielded wall luminaires have already become classics: they come in simple geometric glass shapes with an impressive light effect. Luminaires that catch the eye wherever they are used. The LED light source lies at the centre of the luminaire, behind a metal shield – the three-ply opal glass distributes luminosity all the way to the edge of the glass. Luminaires that seem like wall sculptures when unlit and feature a unique contrasting effect between the glass and metal when lit.





Size
Ø 200 · 320 mm

Luminaire luminous flux
555 · 1335 lm

Connected wattage
10.0 · 19.0 W

Colour temperature
3000 K

LED module

Colour rendering index
CRI > 90

Power supply unit
on/off · DALI controllable

BEGA Thermal Management®

Material
Three-ply opal glass

Metal shield finish

Q P0215



Size
Ø 200 · 320 mm

Luminaire luminous flux
530 · 1360 lm

Connected wattage
10.0 · 19.0 W

Colour temperature
3000 K

LED module

Colour rendering index
CRI > 90

Power supply unit
on/off · DALI controllable

BEGA Thermal Management®

Material
Three-ply opal glass

Metal shield finish

Q P0158



WALL LUMINAIRES

Glass of unrivalled quality

Light objects that are far from just being useful light sources. The premium-quality glass embodies luxury and elegance. Our glassmakers create each individual glass with meticulous craftsmanship. The white, light-diffusing inner body is embedded in a thick layer of clear crystal glass.

The clear “ice edges” of the crystal glass give the luminaire body brilliance – lit or unlit.

But these luminaires also excel when it comes to technology: high-end, high-performance LED modules, DALI controllable power supply units, a colour rendering index greater than 90 and an option to select the light colour for the LED.



Protection class
IP 44



Size
Ø 340 · 390 · 470 mm

Luminaire luminous flux
1540–3340 lm

Connected wattage
19.1–35.0 W

Colour temperature
3000K · 4000K

LED module

Colour rendering index
CRI > 90

Power supply unit
DALI controllable

BEGA Thermal Management®

Material
Crystal opal glass

Q P0192



WALL LUMINAIRES

Pure glass

The closed luminaires with a clear, geometrical shape emit their light away from the wall and into the room, but the unshielded light is also reflected gently on the wall surface.

Our glassmakers create each individual glass with meticulous craftsmanship – resulting in artful, three-ply luminaire glass covers. A thin, translucent layer of opal

glass is enclosed between two layers of crystal glass for superior visual comfort and a uniform light distribution throughout. Whether arranged individually or in groups: they brighten the room with soft and gentle, velvety light.

Economical luminaires for stylish lighting in many interior design applications.



Width
245 · 340 · 430 mm

Luminaire luminous flux
750 – 1910 lm

Connected wattage
10.0 – 30.0 W

Colour temperature
3000 K

LED
BEGA AC module

Colour rendering index
CRI > 90

BEGA Thermal Management®

Material
Three-ply opal glass

Q P0155

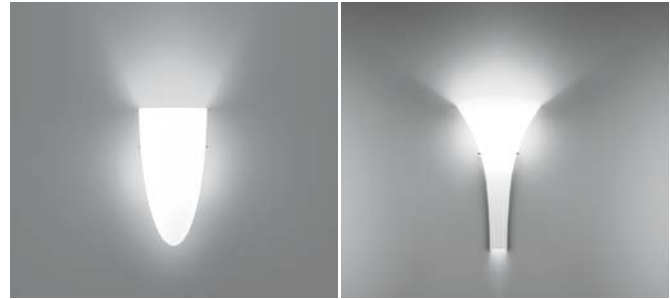

WALL LUMINAIRES

Convex and concave

Two unshielded wall luminaires that are seemingly made of nothing but glass. When lit, it almost seems as if they were floating just in front of their mounting surface.

They are elegant light sources, whether as single luminaires on columns or pillars or evenly arranged across the room.

Among unshielded luminaires, these are the true all-rounders. They are not limited to any particular style, which means they can be used in contemporary architecture as well as in stylishly furnished older buildings.

Our glassmakers create each individual glass with meticulous craftsmanship – resulting in artful, three-ply luminaire glass covers. A thin layer of translucent opal glass is encased between two layers of crystal glass to ensure optimal visual comfort and uniform light distribution.

The glass' lines as well as the varying distances between the lamps and the glass create a fascinating, highly nuanced light that is indirectly reflected from the surface of the wall.

**Height**

210 · 325 mm

Luminaire luminous flux

755 · 1050 lm

Connected wattage

10.0 · 14.0 W

Colour temperature

3000 K

LED

BEGA AC module

Colour rendering index

CRI > 90

BEGA Thermal Management®**Material**

Three-ply opal glass

Q P0150

**Height**

350 · 440 · 560 mm

Luminaire luminous flux

720 – 2250 lm

Connected wattage

10.0 – 28.0 W

Colour temperature

3000 K

LED

BEGA AC module

Colour rendering index

CRI > 90

BEGA Thermal Management®**Material**

Three-ply opal glass

Q P0117





WALL LUMINAIRES

Glassmaking at its best

A row of wall luminaires that emit their light just as elegantly as single unshielded luminaires on columns or pillars or evenly arranged across the room.

They are all available in various dimensions and light outputs and are true all-rounders that are never limited to just one architectural style. That is why they are used in contemporary architecture as well as stylishly furnished older buildings.

Choose a suitable luminaire type from the design alternatives shown here to suit your lighting situation. All three types are available in various dimensions and light outputs. This offers you flexibility in terms of proportions and lighting technology features.

Unshielded wall luminaires

**Height**

410 · 510 · 610 · 710 mm

Luminaire luminous flux

1465–4700 lm

Connected wattage

14.6–40.4 W

Colour temperature

3000 K

LED module**Colour rendering index**

CRI > 90

Power supply unit

DALI controllable

BEGA Thermal Management®**Material**

Three-ply opal glass

Metal fitting finish

Q P 0250



Height
220 · 300 · 485 mm

Luminaire luminous flux
435 – 1980 lm

Connected wattage
7.4 – 22.3 W

Colour temperature
3000 K

LED
LED module · BEGA AC module

Colour rendering index
CRI > 90

Power supply unit
DALI controllable

BEGA Thermal Management®

Material
Three-ply opal glass

Metal fitting finish



Q P 0193



Height
175 · 290 · 425 · 560 mm

Luminaire luminous flux
780 – 1865 lm

Connected wattage
10.0 – 22.6 W

Colour temperature
3000 K · 4000 K

LED
LED module · BEGA AC module

Colour rendering index
CRI > 90

Power supply unit
on/off · DALI controllable

BEGA Thermal Management®

Material
Three-ply opal glass

Metal fitting finish



Q P 0125

WALL LUMINAIRES

Focus on glass

A selection of compact, unshielded wall luminaires that brighten rooms with their gentle, glare-free light. The light is directed upward and downward directly onto the installation surface, creating beautiful light images. Our glassmakers create each individual glass with meticulous craftsmanship – resulting in artful, three-ply luminaire glass covers. A thin layer of translucent opal glass is encased between two layers of crystal glass to ensure optimal visual comfort and uniform light distribution.

The glass' lines as well as the varying distances between the lamps and the glass create a fascinating, highly nuanced light that is indirectly reflected from the surface of the wall.

High-quality luminaires and enduring elements of interior design for sophisticated indoor lighting of the highest quality.





Unshielded wall luminaires



Height
160 · 220 mm

Luminaire luminous flux
840 · 1615 lm

Connected wattage
10.0 · 20.0 W

Colour temperature
3000K

LED
BEGA AC module

Colour rendering index
CRI > 90

BEGA Thermal Management®

Material
Three-ply opal glass

Metal fitting finish



Q P 0262



Height
140 · 170 mm

Luminaire luminous flux
370 · 860 lm

Connected wattage
4.0 · 10.0 W

Colour temperature
3000 K

LED
BEGA AC module

Lamp
G9 LED lamp included

Colour rendering index
CRI >80 · >90

BEGA Thermal Management®

Material
Three-ply opal glass

Metal fitting finish



Q P0264



Height
170 · 350 mm

Luminaire luminous flux
535 · 1000 lm

Connected wattage
7.4 · 14.8 W

Colour temperature
3000 K

LED
BEGA AC module

Colour rendering index
CRI >90

BEGA Thermal Management®

Material
Three-ply opal glass

Metal fitting finish



Q P0254

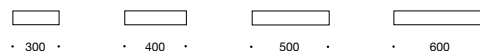

WALL LUMINAIRES Linear light

These two wall luminaire groups are suitable for a multitude of indoor applications. Both are linear, unshielded luminaires and are available in various design lengths. That means that they can be installed in a horizontal or vertical operating position.

One of the model series comes with the protection class IP 44. They are VDE 0100-compliant, which makes them suitable for use in sanitary areas, where this protection class is required. All luminaires feature hand-blown satin matt opal glass for gentle and uniform light.





Unshielded wall luminaires

Length
300 · 400 · 500 · 600 mm

Luminaire luminous flux
695 – 1490 lm

Connected wattage
7.8 – 16.1 W

Colour temperature
2700 K · 3000 K

LED module

Colour rendering index
CRI > 90

Power supply unit
on/off

BEGA Thermal Management®

Material
Three-ply opal glass

Finish



With power switch

Q P0165



Protection class
IP 44

Length

400 · 500 · 600 mm

Luminaire luminous flux

460 – 1700 lm

Connected wattage

8.0 – 19.5 W

Colour temperature

2700 K · 3000 K

LED module

Lamp

E14 LED lamps included

Colour rendering index

CRI > 80 · > 90

Power supply unit

on/off · DALI controllable

BEGA Thermal Management®

Material

Three-ply opal glass

Finish



Q P0153

WALL LUMINAIRES

Glass bodies of impressive length

Linear wall luminaires with unshielded opal glass cylinders. Two luminaire groups with similar design characteristics, but with different lengths and light outputs.

Luminaires that score highly in terms of lighting technology features and material quality.

The hand-blown opal glass is held in place by precise metal fittings. The glass-to-metal transitions have the same diameter and are just as attractive in their design as their gentle, colour neutral and uniform light distribution.

Light quality and visual comfort play an important role on mirror surfaces in bathrooms. These unshielded luminaires more than satisfy the highest expectations for great light. Their high protection class makes them ideal for this area of application: they fulfil the required protection class IP 44 in compliance with VDE0100.

The luminaires can be installed in a horizontal or vertical position.

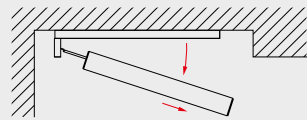

An internal mechanism allows the glass to be swivelled in and out. This means that they can also be installed in niches from wall to wall, optionally in horizontal or vertical position.







Protection class
IP 65

Unshielded wall luminaires

Length
500 · 600 · 700 · 1000 mm

Luminaire luminous flux
1300–3555 lm

Connected wattage
19.5–39.0 W

Colour temperature
3000 K

LED module

Colour rendering index
CRI > 90

Power supply unit
DALI controllable

BEGA Thermal Management®

Material
Three-ply opal glass

Finish



Q P0111



Protection class
IP 44

Length
500 · 600 · 700 · 900 mm

Luminaire luminous flux
910–2170 lm

Connected wattage
8.8–22.4 W

Colour temperature
3000 K

LED module

Colour rendering index
CRI >90

Power supply unit
on/off

BEGA Thermal Management®

Material
Three-ply opal glass

Finish

Q P 0126



WALL LUMINAIRES

High-precision shapes with protection class IP 44

The design and area of application of the wall luminaires shown here have a long tradition in our product range. We have developed the wall luminaires of this model series for very special applications: with a very careful design to match our LED technology. Their IP 44 protection class also makes them the perfect choice for bathrooms in compliance with VDE 0100.

The luminaires are available in various lengths and with two finishes and also come with their own DALI controllable power supply units. Luminaires that can be installed horizontally as well as vertically and ensure perfect visual comfort – also beyond the bathroom.



Protection class
IP 44

Length
600 · 800 · 1000 mm

Luminaire luminous flux
2600 – 4400 lm

Connected wattage
26.6 – 44.3 W

Colour temperature
3000 K

LED module

Colour rendering index
CRI >90

Power supply unit
DALI controllable

BEGA Thermal Management®

Material
White, translucent
synthetic cover

Finish



Q P0101



Infinitely adjustable light distribution



The design and technology of these luminaires allow the light to be directed in several directions. The light emission opening can be infinitely adjusted on the luminaire axis.



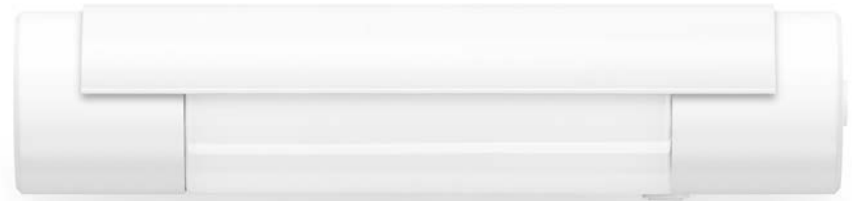

Length
340 mm

Luminaire luminous flux
290 lm

Connected wattage
5.9 W

Colour temperature
3000 K

LED module

Colour rendering index
CRI > 90

Power supply unit
on/off · BEGA Ultimate Driver®
Power switch

BEGA Thermal Management®

Material
Three-ply opal glass

Finish



Q P 0228



Length
300 · 450 mm

Luminaire luminous flux
460 · 835 lm

Connected wattage
6.2 · 10.0 W

Colour temperature
3000 K

LED module

Colour rendering index
CRI > 90

Power supply unit
on/off
Power switch

Material
Three-ply opal glass

Finish



Q P 0206

VARIATA WALL LUMINAIRES

Great light in the blink of an eye

These luminaires allow adjusting of their luminous energy wherever concentrated light is needed to match individual light requirements.

The shields of both luminaires are infinitely rotatable around their longitudinal axis. This means their light emission can be shielded towards the front or directed upward or downward.

VARIATA luminaires are available with a surface-mounted shield or one with the same diameter.



STUDIO LINE WALL LUMINAIRES

Open for light in two directions

A wall luminaire that has it all. This luminaire from the STUDIO LINE series distributes its light upward and downward on its mounting surface – and its LED light source is mounted barely visible on the inside of the luminaire housing. From here, the light is directed to the wall surface.

A luminaire that is open towards the top and bottom and not only features high-end materials, but also creates a beautiful lighting atmosphere.

Choose from two design lengths and six colour combinations to find the right luminaires to match your interior theme.





Length

300 · 500 mm

Luminaire luminous flux

675 – 1345 lm

Connected wattage

13.7 · 29.0 W

Colour temperature

3000 K

LED module

Colour rendering index

CRI > 90

Power supply unit

on/off

BEGA Thermal Management®

Outside colour



Inside colour



Q P 0241



STUDIO LINE WALL LUMINAIRES AND ILLUMINATED MIRRORS

Endless design options

Here, the transition between luminaire and wall sculpture is fluid – these three model series go far beyond just function. They are luminaire and light object in one and lend themselves for virtually endless design options in terms of shape and material characteristics.

All models in this fascinating group of wall luminaires are available with various diameters to add to the creative planning options for attractive installations. Lit or unlit – they are true eye-catchers. Choose between a velvet black or velvet white outside colour and the various inside colour hues to find the right combination to match your interior theme. Luminaire and illuminated mirror – highlighting private living spaces and many other areas of high-end interior design.



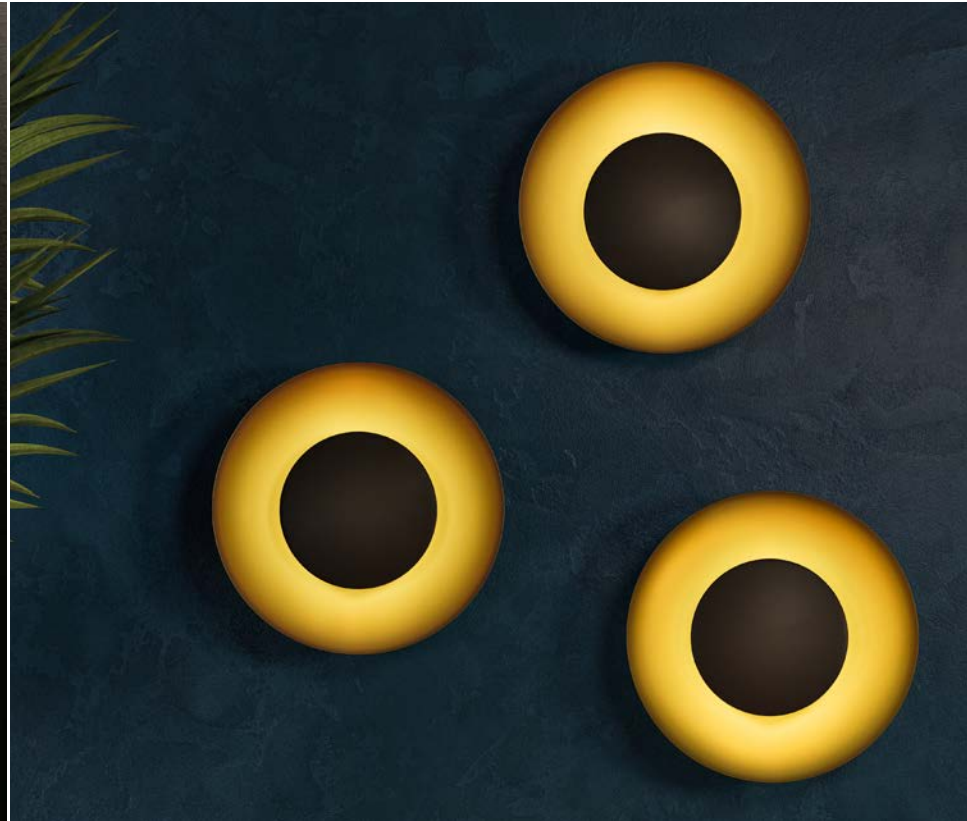

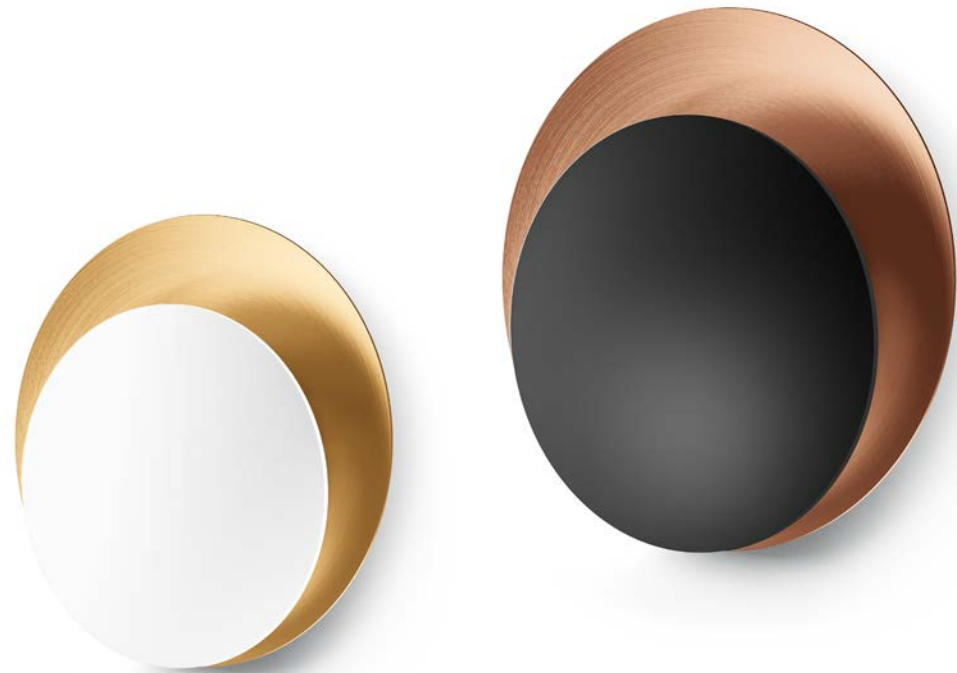

STUDIO LINE
Wall luminaires



Page 223

Size
Ø 400 · 500 mm

Luminaire luminous flux
505 – 700 lm

Connected wattage
18.6 · 26.8 W

Colour temperature
3000 K

LED module

Colour rendering index
CRI > 90

Power supply unit
DALI controllable

BEGA Thermal Management®

Material
Internal white, translucent
synthetic cover

Outside colour



Inside colour



Q P0184



Size
Ø 500 · 700 mm

Luminaire luminous flux
260 · 400 lm

Connected wattage
28.3 · 36.5 W

Colour temperature
3000 K

LED module

Colour rendering index
CRI > 90

Power supply unit
on/off · DALI controllable

BEGA Thermal Management®

Material
White, translucent synthetic cover

Outside colour



Inside colour



Q P0159



Size
Ø 500 · 700 mm

Luminaire luminous flux
1170 · 2870 lm

Connected wattage
30.0 · 58.5 W

Colour temperature
3000 K

LED module

Colour rendering index
CRI > 90

Power supply unit
DALI controllable

BEGA Thermal Management®

Material
White, translucent synthetic cover

Outside colour



Inside colour



Q P0191

STUDIO LINE WALL LUMINAIRES

Light emission on two sides in different variations

These wall luminaires with light emission on two sides are perfect for the illumination of wall areas, columns or to frame doorways in rooms and in corridors. Their light is emitted upward and downward and creates beautiful light images on the mounting area, which doubles as a reflection surface for the shielded light.

These luminaires of the STUDIO LINE series feature economical and reliable LED technology as well as a fascinating interplay of various metal finishes. For each of the luminaires, you can choose from various colour combinations, sizes and light outputs to match your interior theme.



STUDIO LINE finishes

Velvet white or velvet black outside colour



Inside colour matt aluminium



Inside colour matt brass



Inside colour matt copper

Depending on the inside colour of the luminaire, the light will have a neutral or warm tint.





STUDIO LINE
Wall luminaires

Length
180 · 220 mm

Luminaire luminous flux
165–365 lm

Connected wattage
10.0 · 14.0 W

Colour temperature
3000 K

LED
BEGA AC module

Colour rendering index
CRI > 90

BEGA Thermal Management®

Outside colour



Inside colour



Page 53



Page 81

Q P 0134



Length

210 · 250 mm

Luminaire luminous flux

450 – 1040 lm

Connected wattage

19.5 · 28.0 W

Colour temperature

3000 K

LED module

Colour rendering index

CRI > 90

Power supply unit

DALI controllable

BEGA Thermal Management®

Outside colour



Inside colour



Page 53



Page 81



Page 215

Q P0217

Length

500 · 600 mm

Luminaire luminous flux

405 – 960 lm

Connected wattage

19.5 · 28.0 W

Colour temperature

3000 K

LED module

Colour rendering index

CRI > 90

Power supply unit

DALI controllable

BEGA Thermal Management®

Outside colour



Inside colour



Q P0214





Page 211



Page 263



STUDIO LINE WALL LUMINAIRES

Light to create the right ambiance

A wall luminaire reminiscent of the traditional luminaire shapes that creates an attractive contrast with its unconventional wall mounting. The metallic luminaire shield hides next generation LED modules, which distribute their light upward and downward, as well as a DALI controllable power supply unit.

Choose between a white or black outside colour and the two metallic inside colours to find the right combination to match your interior theme.

Luminaires that shine in private living spaces and turn heads in many public areas with sophisticated interior design.

Length
435 mm

Luminaire luminous flux
1020 · 1100 lm

Connected wattage
19.5 W

Colour temperature
3000K

LED module

Colour rendering index
CRI > 90

Power supply unit
DALI controllable

BEGA Thermal Management®

Material
Translucent synthetic cover
with optical texture

Outside colour



Inside colour



Q P0233

PENDANT LUMINAIRES

Uncompromising shape

Pendant luminaires with brilliant crystal glass and cast aluminium luminaire housings – two luminaires with different shapes, but with the same technical features. A reflector in the interior of the luminaire housing generates the downward directed light portion.

The compelling design of these luminaires is highlighted by beautiful, hand-crafted crystal glass, which produces a faceted play of light. Their brilliance rounds off the look. Both series are available in various sizes and light outputs to suit whatever lighting design you are planning.

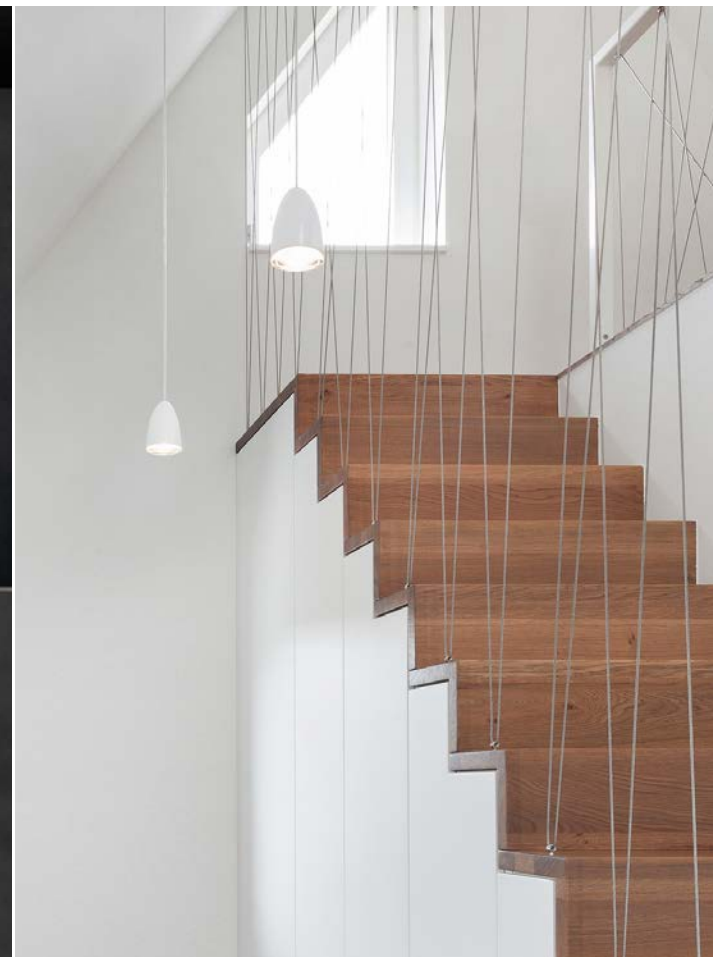



Page 61



Page 119

Size

Ø 120 · 135 · 180 mm

Luminaire luminous flux

885–1655 lm

Connected wattage

9.8–19.5 W

Half beam angle

49°–55°

Colour temperature

3000 K

LED module

Colour rendering index

CRI > 90

Power supply unit

on/off · DALI controllable

Optical system

Constant Optics®

BEGA Thermal Management®

Material

Partially frosted crystal glass

Finish



Q P0190



Size

Ø 95 · 135 · 155 mm

Luminaire luminous flux

180–1605 lm

Connected wattage

4.8–19.0 W

Colour temperature

3000 K · 4000 K

LED module

Colour rendering index

CRI > 90

Power supply unit

on/off · DALI controllable

BEGA Thermal Management®

Material

Partially frosted crystal glass

Finish



Q P0195

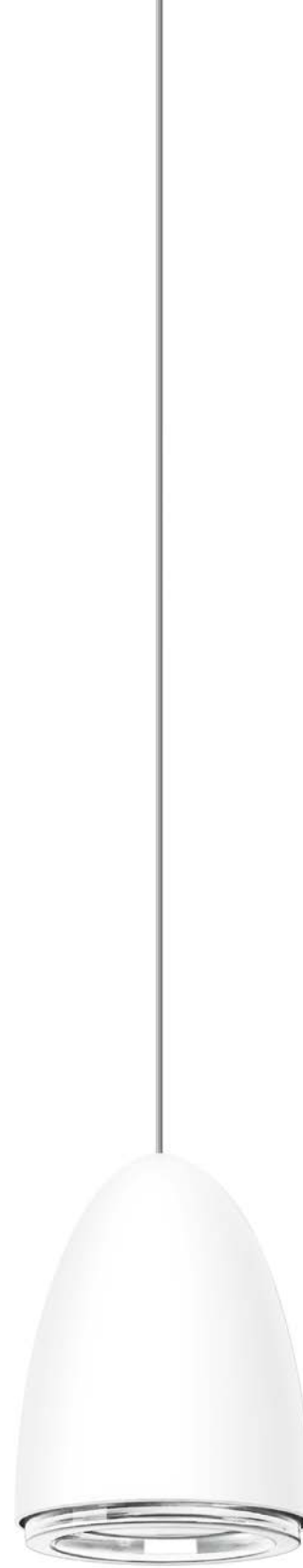

PENDANT LUMINAIRES

As downlights or unshielded

The same, only different: Choose between pendant luminaires with clear crystal glass for brilliant light or pendant luminaires with hand-blown opal glass for a soft and uniform light distribution.

The luminaires with crystal glass rely on dual light distribution: they emit their light into the room in two ways. The powerful light portion directed downward is bundled at the centre of the reflector via an integrated focusing/diffusing lens made of crystal glass. At the same time, some of the diffuse light percentage is used for the illumination of the luminaire glass and for vertical illuminance.

The mix of downward directed and vertical luminous intensity ensures excellent visual comfort.

Our glassmakers create each individual glass with meticulous craftsmanship – both versions have an effect on the lighting atmosphere in the room.

They are available in various sizes and light outputs to suit whatever lighting design you are planning.

You can furthermore choose between various housing finishes.





Page 63



Page 37

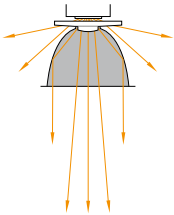

Size

Ø 145 · 200 · 255 · 300 mm

Luminaire luminous flux

1140–3540 lm

Connected wattage

10.6–39.5 W

Half beam angle

36°–61°

Colour temperature

3000 K

LED module

Colour rendering index

CRI >90

Power supply unit

on/off · DALI controllable

BEGA Thermal Management®

Material

Crystal glass

Finish



Q P0168



Size

Ø 145 · 200 · 255 · 300 mm

Luminaire luminous flux

1045–3695 lm

Connected wattage

10.6–39.5 W

Colour temperature

3000 K

LED module

Colour rendering index

CRI >90

Power supply unit

on/off · DALI controllable

BEGA Thermal Management®

Material

Three-ply opal glass

Finish



Q P0239



RGBW additive colour mixing

RGBW allows you to create various colours with quadruple LED in the three primary colours red, green and blue (RGB) plus an additional white LED (W). Mixing the various LED colours enables the rendering of millions of spectral colours in wavelengths between 450 and 620 nanometres. The white LED impacts the colour saturation and creates soft pastel hues.





PENDANT LUMINAIRES

Unshielded and downlighting all-rounders

These pendant luminaires offer a broad output spectrum and additional lighting technology options for sophisticated lighting design projects. Often, two requirements are deciding factors in lighting design: a high degree of illuminance on the surface to be illuminated and an additional unshielded portion of light to provide vertical illuminance. These pendant luminaires combine both functions. In all three luminaire types, the unshielded portion of light is generated by LED modules with different outputs. Integrated downlights with a very wide beam light distribution additionally create efficient

directed light. Two of these luminaires also come with an additional light emission towards the top for applications where the aim is to additionally illuminate ceiling or architectural features above the luminaires. The individual light functions are separately DALI controllable and can create virtually any desired lighting atmosphere. In RGBW-type luminaires, the unshielded portion of light and the light emitted upward can be individually colour-controlled. The downward-directed light of the downlight will always be either 3000 K or 4000 K.

Optional light emission upwards



Pendant luminaires · Downlights

Size

H 480 · 570 mm
Ø 185 · 220 mm

Luminaire luminous flux

1055 – 11 620 lm

Connected wattage

16.0 – 121.3 W

Half beam angle

85°

Colour temperature

3000 K · 4000 K

LED module

Colour rendering index

CRI >90

Power supply unit

DALI controllable

Optical system

Constant Optics®

BEGA Thermal Management®

Material

Three-ply opal glass
Safety glass

Finish



Q P 0279



Height

310 · 370 mm

Luminaire luminous flux

1350 – 6415 lm

Connected wattage

16.0 – 70.3 W

Half beam angle

85°

Colour temperature

3000 K · 4000 K

LED module

Colour rendering index

CRI >90

Power supply unit

DALI controllable

Optical system

Constant Optics®

BEGA Thermal Management®

Material

Three-ply opal glass
Safety glass

Finish



Q P0182



Light emission upwards

Size

Ø 450 · 550 · 650 mm

Luminaire luminous flux

7690 – 18 520 lm

Connected wattage

11.0 – 174.1 W

Half beam angle

85°

Colour temperature

3000 K · 4000 K

LED module

Colour rendering index

CRI >90

Power supply unit

DALI controllable

Optical system

BEGA Constant Optics®

BEGA Thermal Management®

Material

White, translucent synthetic cover
Safety glass

Finish



Q P0145



Pendant luminaires for large rooms

For application options in large architectural spaces, we offer exceptionally efficient pendant luminaires in dimensions that make them particularly suitable for high ceilings.

In such spaces, lighting design often also demands a high degree of illuminance on the area to be illuminated as well as an unshielded portion of light for vertical illuminance within the room.

These pendant luminaires for large rooms combine the two functions: you can choose from unshielded luminaires or those that have an additionally integrated downlight for your planning. LED modules generate the unshielded portion of light in the white synthetic cylinder. Luminaires with an integrated downlight also provide efficient light with a very wide beam light distribution. Both lighting functions are separately DALI controllable and allow the setting of customised lighting atmosphere scenarios.



Height
1780 mm

Luminaire luminous flux
1595 · 12 535 lm

Connected wattage
19.3 · 120.0 W

Colour temperature
3000 K · 4000 K

LED module

Colour rendering index
CRI >90

Power supply unit
DALI controllable

BEGA Thermal Management®

Material
White, translucent synthetic cover

Finish



Q P0249

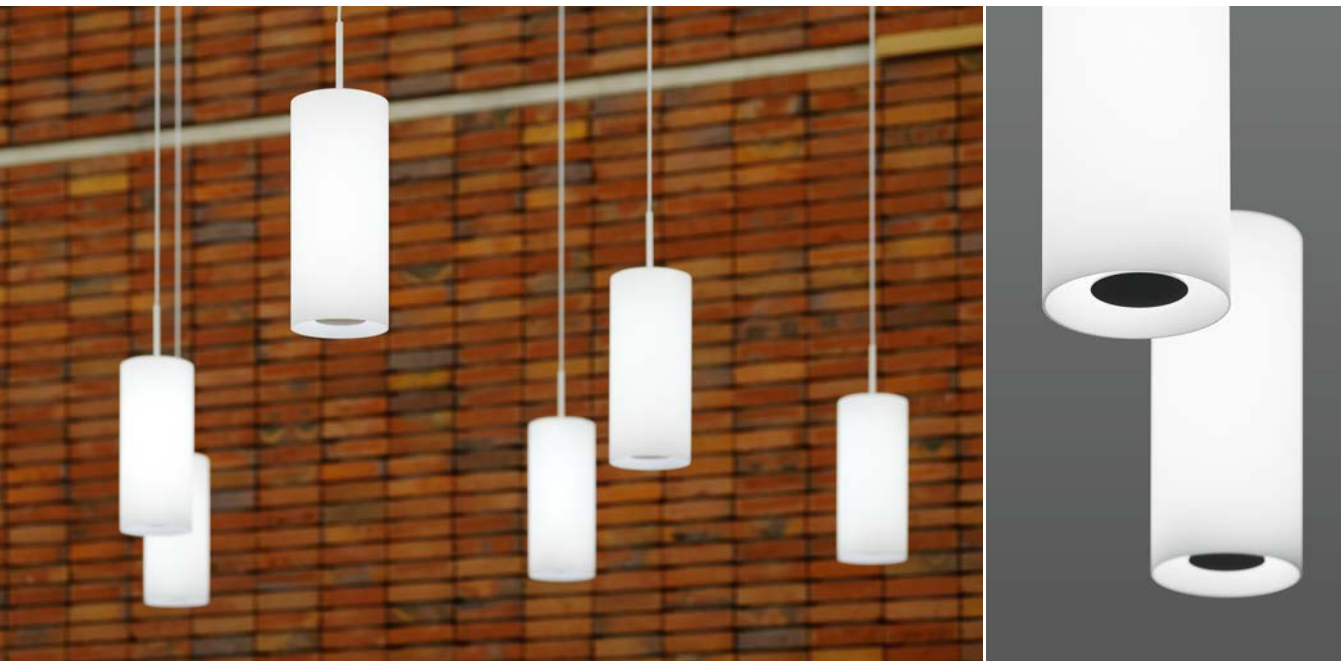

UNSHIELDED PENDANT LUMINAIRES

Sphere or cylinder shape

Sphere and cylinder are the two traditional pendant luminaire shapes that have been used for decades, serving as timeless light sources in countless architectural projects. As unshielded pendant luminaires, these three luminaire series with contemporary lighting technology continue a long tradition of excellence.

There are multiple versions and options to choose from for spherical pendant luminaires. We offer spherical pendant luminaires with cable suspension or traditional rod suspension.

You can choose a spherical pendant made of hand-blown, three-ply opal glass or impact-resistant synthetic material.

We offer the luminaires in a spherical or cylindrical shape in various sizes and light outputs – they are durable and aesthetic design elements for interior architecture that will perform their job as lighting tools for extended times of operation.



Unshielded pendant luminaires

Size

Ø 200 · 250 · 300 · 350 · 400 mm

Luminaire luminous flux

710–7555 lm

Connected wattage

7.0–65.0 W

Colour temperature

2700 K · 3000 K · 4000 K

LED module

Lamp

E 27 LED lamp included

Colour rendering index

CRI >80 · >90

Power supply unit

DALI controllable

Material

Three-ply opal glass
or impact-resistant, white,
translucent synthetic cover

Metal housing and canopy finish



Rod suspension



Cable suspension

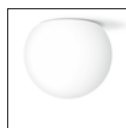

Page 37



Page 67

Q P0188

**Size**

H 280 · 350 · 420 · 550 mm
Ø 120 · 150 · 180 · 220 mm

Luminaire luminous flux

1300 / 5920 lm

Connected wattage

12.0–59.5 W

Colour temperature

2700 K · 3000 K · 4000 K

LED module**Lamp**

E 27 LED lamp included

Colour rendering index

CRI >80 · >90

Power supply unit

DALI controllable

Material

Three-ply opal glass

Metal housing and canopy finish

Q P0166

**Size**

H 300 · 400 · 620 · 700 · 800 mm
Ø 80 · 110 · 140 · 160 · 220 mm

Luminaire luminous flux

710–10 920 lm

Connected wattage

7.0–104.8 W

Colour temperature

2700 K · 3000 K · 4000 K

LED module**Lamp**

E 27 LED lamp included

Colour rendering index

CRI >80 · >90

Power supply unit

DALI controllable

BEGA Thermal Management®**Material**

Three-ply opal glass

Canopy finish

Q P0189



Unshielded pendant luminaires

Two seemingly weightless pendant luminaires that create a memorable light effect and ensure optimal visual comfort – especially when arranged in groups and at differing mounting heights. Both luminaire types are available in various sizes and light outputs to serve as robust and reliable lighting tools that will perform their job for extended periods of

operation. Perfect proportions and the high-end luminaire glass make these luminaire durable and aesthetic design elements for interior architecture.

For applications where glass cannot be used, we provide the same models of luminaires with impact-resistant, translucent synthetic covers.

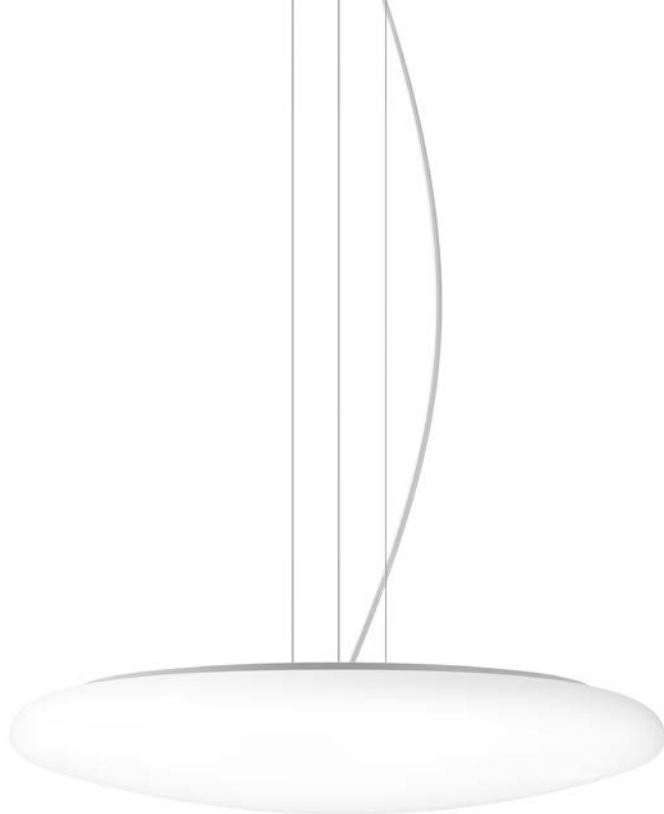

Page 101

Size
Ø 350 · 420 · 510 mm

Luminaire luminous flux
1235–4200 lm

Connected wattage
13.3–35.0 W

Colour temperature
3000 K · 4000 K

LED module

Colour rendering index
CRI > 90

Power supply unit
on/off · DALI controllable

BEGA Thermal Management®

Material
Three-ply opal glass
or impact-resistant, white,
translucent synthetic cover

**Metal fitting and
canopy finish**



Q P0213

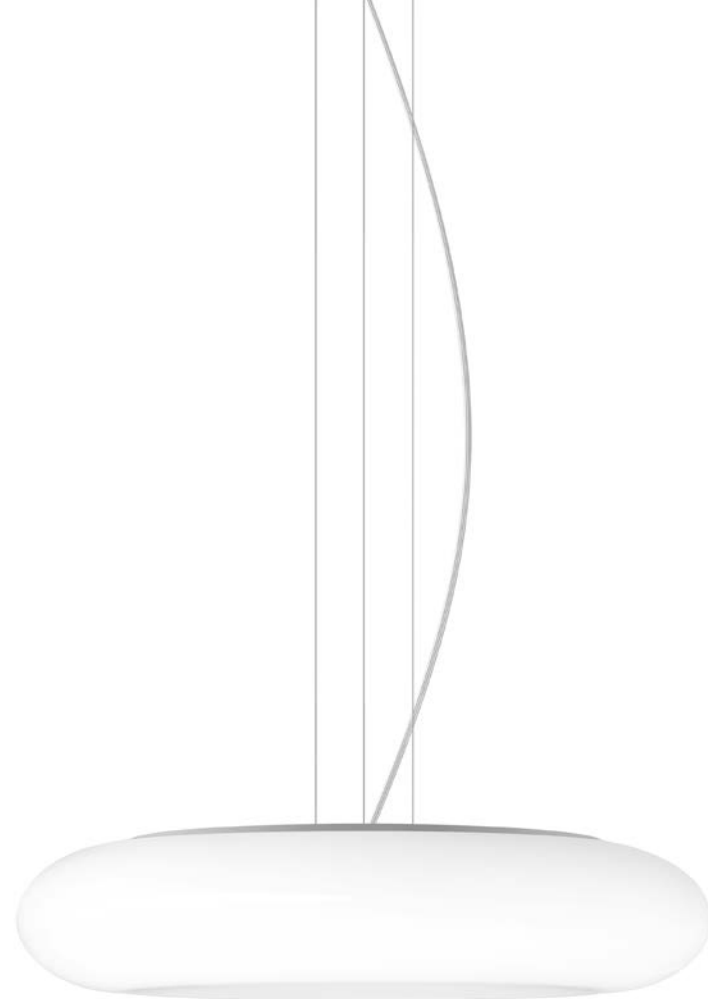

Page 101

Size
Ø 400 · 460 · 560 mm

Luminaire luminous flux
1255–3600 lm

Connected wattage
13.3–35.0 W

Colour temperature
3000 K · 4000 K

LED module

Colour rendering index
CRI > 90

Power supply unit
on/off · DALI controllable

BEGA Thermal Management®

Material
Three-ply opal glass

**Metal fitting and
canopy finish**



Q P0103

PENDANT LUMINAIRES

White or “black” opal glass

Extraordinary pendant luminaires in various sizes, optionally made of white or black overlaid opal glass with LED lamps for G9 and E 27 base. Luminaires with the same form language but different light effects.

Shielded or unshielded: The luminaires made of white opal glass emit part of the light downwards and pass the unshielded light through the glass to

illuminate the room in a pleasant and uniform manner. The interior surfaces of the black glass luminaires are also made of white opal glass. The light from the lamp is reflected downwards in brilliant white. In daylight, the exterior finish appears opaque and deep black. When lit from within, however, the glass displays a fascinating colour spectrum of deep black right up to a subtle blue.



Height

170 · 240 · 285 · 370 mm

Luminaire luminous flux

60 – 1270 lm

Connected wattage

4.0 – 12.0 W

Colour temperature

2700 K · 3000 K

Lamp

G9 or E 27 LED lamp included

Colour rendering index

CRI > 80

Material

Three-ply opal glass

Q P0112 · P0273



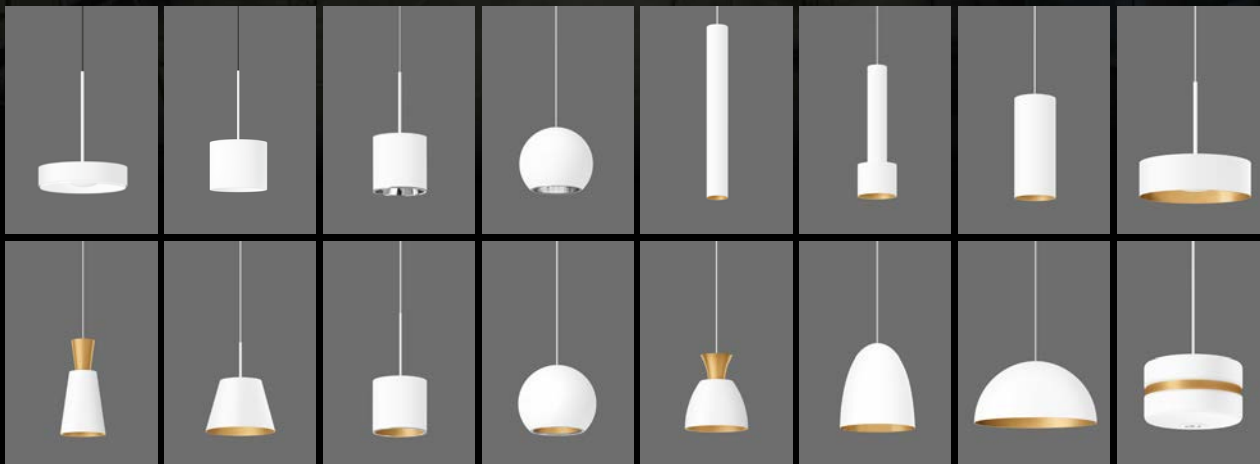

BEGA SYSTEM PENDANT LUMINAIRES

Suitable for any installation situation

As a modular system, BEGA system pendant luminaires allow you to combine pendant luminaires with various installation components for the ceiling.

The electrical connection and suspension of a pendant luminaire on the ceiling are usually achieved by means of a canopy. In addition to safety-related protection against contact voltage, this also serves to conceal the suspension and the cable connection.







However, structural conditions often require pendant luminaires to be installed on a variety of ceiling structures.

For example, the electrical connection of the luminaire and the suspension are supposed to be integrated into a suspended ceiling.

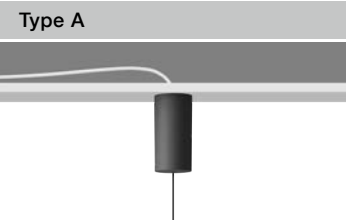
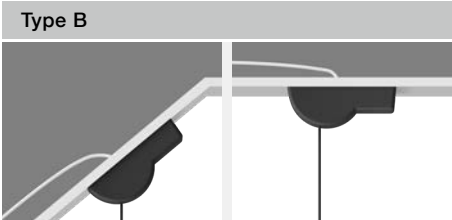
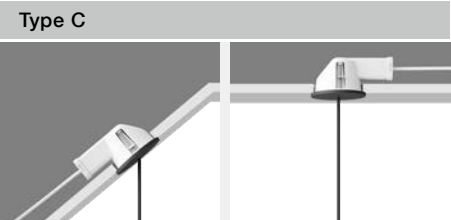
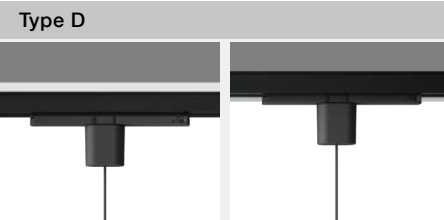
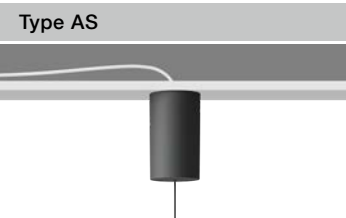
Mounting and installation on slanted ceilings in pitched roofs may also be a requirement, as may be the installation of pendant luminaires on a track system.

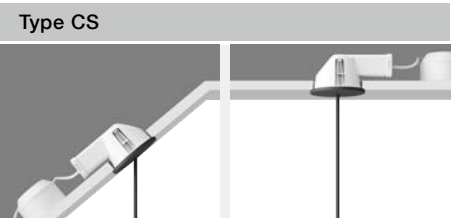
With BEGA system pendant luminaires, you simply order the installation components to match your selected system pendant luminaire for the desired type of installation.

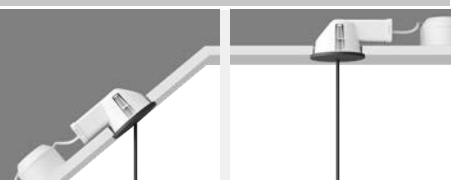
Please observe the technical data of the system pendant luminaires and the installation components when planning. The associated instructions for use can be found on our website.

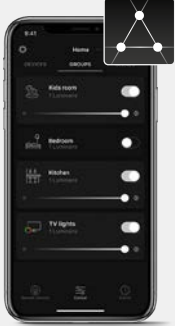
 <p>Type A</p>	 <p>Type B</p>	 <p>Type C</p>	 <p>Type D</p>
<p>Surface-mounted canopy For the electrical installation and mounting of a BEGA system pendant luminaire on any type of ceiling.</p>	<p>Surface-mounted canopy For the mounting and electrical installation of BEGA system pendant luminaires on all types of slanted and level ceilings. Suitable for slanted ceilings with a pitch of 0°–40°.</p>	<p>Recessed canopy For the mounting and electrical installation of a BEGA system pendant luminaire in slanted and level suspended ceilings. Suitable for slanted ceilings with a pitch of 0°–40°.</p>	<p>Track adapter For the integration of a BEGA system pendant luminaire in 3-phase Eurostandard Plus® track systems – as a surface and flush-mounted version.</p>
 <p>Type AS</p>	 <p>Type BS</p>	 <p>Type CS</p>	<p>Type AS · BS · CS</p>
 <p>Surface-mounted canopy · Smart Identical in construction to type A, but with built-in Smart Controller for wireless control of the luminaire using BEGA Smart.</p>	 <p>Surface-mounted canopy · Smart Identical in construction to type B, but with built-in Smart Controller for wireless control of the luminaire using BEGA Smart.</p>	 <p>Recessed canopy · Smart Identical in its design to type C, but with integrated Smart Controller for wireless control of the luminaire using BEGA Smart.</p>	<p>works with BEGA Smart</p>  <p>You can find more information about BEGA Smart on Page 6 or online at bega.com/smart</p>

The actual dimensions of the installation components may vary from the schematics. Instructions for use with all technical data can be found on our website at www.bega.com/system-pendants.

SYSTEM PENDANT LUMINAIRES

Spherical and cylindrical downlights

Sphere and cylinder – two classic pendant luminaires that may differ in their form, but offer identical light technology features.

They utilise the advantages of our highly efficient BEGA Hybrid Optics® technology.

These model series are available in various sizes, half beam angles and light outputs to suit whatever lighting design you are planning.

The pendant luminaires offer additional benefits when used as part of a system. Simply choose the appropriate ceiling connection for your

electrical installation to match the luminaire type of your choice. Suitable canopies are available as e.g. surface-mounted or recessed canopies for level or slanted ceilings, or as adapters for 3-phase Eurostandard Plus® track systems.

We recommend choosing the matching smart version of the canopy if you want your luminaire to be controlled via the BEGA Smart app.

You will find an overview of matching system components on Page 195.

BEGA Hybrid Optics® The perfect match

BEGA utilises BEGA Hybrid Optics® technology to maximise the efficiency of technical indoor and outdoor luminaires.

Luminaires with this optical system rely on the perfect interplay of precisely dimensioned reflectors with a pure aluminium finish and ultra-clear silicone lenses.

In these luminaires, virtually every beam of light emitted by the LED modules is captured by the BEGA Hybrid Optics® technology, directed and used for optimal light distribution. That is the biggest difference between hybrid optics and conventional light deflection methods, in which much of the light leaves the luminaire without being deflected.







works with
BEGA Smart

System pendant luminaires · Downlights

Size

Ø 140 · 190 mm

Luminaire luminous flux

1015–2000 lm

Connected wattage

14.0 · 19.8 W

Half beam angle

27°–61°

Colour temperature

3000 K

LED module

Colour rendering index

CRI >90

Power supply unit

on/off · DALI controllable

Optical system

BEGA Hybrid Optics®

Material

Safety glass

Finish



Light distribution



Page 70



Page 58

Q P0216



Size
Ø 90 · 120 · 135 · 180 mm

Luminaire luminous flux
385 – 3535 lm

Connected wattage
5.0 – 29.0 W

Half beam angle
30° – 74°

Colour temperature
3000 K

LED module

Colour rendering index
CRI >80 · >90

Power supply unit
on/off · DALI controllable

Optical system
BEGA Hybrid Optics®

BEGA Thermal Management®

Material
Safety glass

Finish



Light distribution

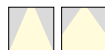

Q P 0226



Page 70



Page 59



Upward light gain

Being able to fall back on our own LED and glass production when new ideas are being implemented has always been a major advantage for us.

We have developed special LED modules for these two pendant luminaires and combined them in a unique way with a patented glass structure to create luminaire glass with two light intensities.

We call this luminaire glass DUOLOGIC.

The basic principle of these luminaires is to direct the maximum luminous intensity of the LED through the relevant luminaire glass directly downward onto the area to illuminate to ensure the greatest possible brightness. The second zone of light is emitted upward in the

shielded pendant luminaire to emphasise the lower glass edge of the luminaires.

A metal shield also ensures perfect lateral glare suppression.

In the unshielded pendant luminaire, the second light zone impacts the exterior of the glass. This will give the outer glass surface luminance with high visual comfort.

These luminaires are suitable for a variety of lighting applications above tables, counters or reception desks.

Choose the relevant smart version of the canopy if you want to control your luminaire via the BEGA Smart app.

You will find an overview of matching system components on Page 195.



DUOLOGIC: Part of the light exits from the top of the metal shield, illuminating the area above the luminaire and increasing visual comfort.



works with
BEGA Smart

System pendant luminaires with DUOLOGIC glass

Size
Ø 160 · 180 mm

Luminaire luminous flux
545 · 1550 lm

Connected wattage
7.3 · 15.9 W

Colour temperature
3000 K · 4000 K

LED module

Colour rendering index
CRI >90

Power supply unit
on/off · DALI controllable

Material
DUOLOGIC opal glass

Finish



Q P0147

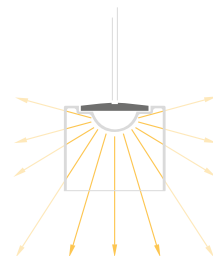



Size
Ø 160 · 210 · 260 mm

Luminaire luminous flux
485–2035 lm

Connected wattage
7.3–20.6 W

Colour temperature
3000 K · 4000 K

LED module

Colour rendering index
CRI >90

Power supply unit
on/off · DALI controllable

Material
DUOLOGIC opal glass

Finish



Q P0100

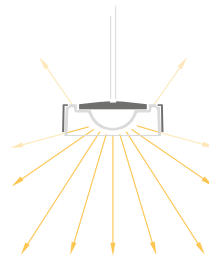



works with
BEGA Smart

Unshielded System pendant luminaires

The light of these unshielded pendant luminaires creates excellent room illumination. These efficient luminaires emit light upwards onto the ceiling and downwards towards the floor in equal measures.

One model comes with an additionally integrated downlight, which increases the degree of illuminance underneath the luminaire and adds to the unshielded light.

The luminaires are DALI controllable; the luminous intensity can be adjusted to match specific lighting requirements.

Choose the relevant smart version of the canopy if you want to control your luminaire via the BEGA Smart app.

You will find an overview of matching system components on Page 195.



Available with a very wide beam downlight

Size
Ø 250 · 350 mm

Luminaire luminous flux
2400 – 4300 lm

Connected wattage
22.0 – 40.0 W

Colour temperature
3000 K

LED module

Colour rendering index
CRI > 90

Power supply unit
DALI controllable

Material
White, translucent
synthetic cover

Metal ring finish



Q P 0266



STUDIO LINE

Spherical and cylindrical system pendant luminaires

Sphere or cylinder – the light from these LED pendant downlights is directed by a reflector and shielded when emitted into the room. A portion of the light emits directly downward, while the remaining luminous energy is reflected by the metallic interior, producing a soft tinting depending on the chosen finish.

Luminaires of the STUDIO LINE luminaire series in various sizes and light outputs that create an attractive lighting atmosphere. They boast both economical and reliable LED technology as well as a fascinating interplay of different materials.

The luminaires are available with on/off or DALI controllable power supply units.

Choose from six colour combinations to match the luminaires to your interior.

We recommend choosing the matching smart version of the canopy if you want your luminaire to be controlled via the BEGA Smart app.

You will find an overview of matching system components on Page 195.

STUDIO LINE finishes

Velvet white or velvet black outside colour

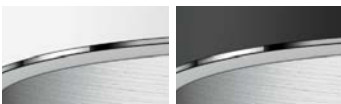

Inside colour matt aluminium



Inside colour matt brass



Inside colour matt copper

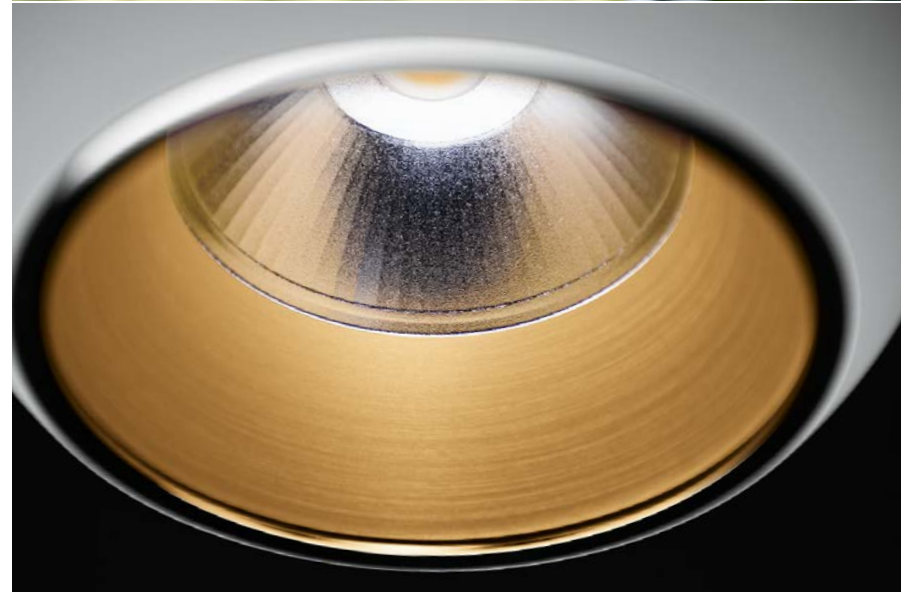





Page 78



Page 78



Page 259

works with
BEGA Smart

STUDIO LINE

System pendant luminaires

Size
Ø 140 · 190 mm

Luminaire luminous flux
890 – 1660 lm

Connected wattage
14.0 · 19.8 W

Half beam angle
26°–43°

Colour temperature
3000 K

LED module

Colour rendering index
CRI > 90

Power supply unit
on/off · DALI controllable

Outside colour



Inside colour



Q P0120





Page 79



Size
Ø 90 · 120 · 135 · 180 mm

Luminaire luminous flux
325–1860 lm

Connected wattage
5.6–20.0 W

Half beam angle
22°–35°

Colour temperature
3000 K

LED module

Colour rendering index
CRI > 90

Power supply unit
on/off · DALI controllable

BEGA Thermal Management®

Outside colour



Inside colour



Q P 0275



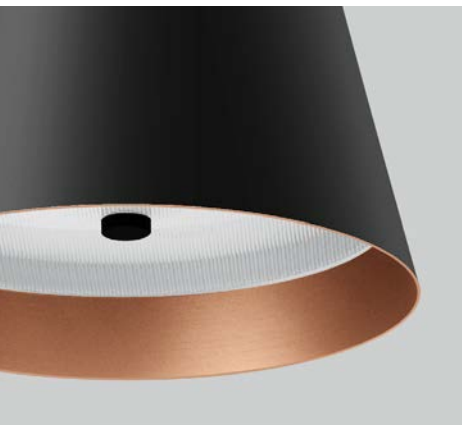

STUDIO LINE

System pendant luminaires

The light from these two series of shielded pendant luminaires creates a uniformly soft and pleasant lighting atmosphere. Luminaires that feature economical and reliable LED technology as well as a fascinating interplay of various materials.

Choose the luminaires to match your interior theme – from six colour combinations in various sizes and light outputs.

Choose the relevant smart version of the canopy if you want to control your luminaire via the BEGA Smart app.

You will find an overview of matching system components on Page 195.



works with
BEGA Smart

Size

Ø 145 · 200 · 255 mm

Luminaire luminous flux

540–1575 lm

Connected wattage

12.0–20.7 W

Colour temperature

3000 K

LED

LED module

Lamp

E 27 LED lamp included

Colour rendering index

CRI >80 · >90

Power supply unit

on/off · DALI controllable

Material

White, translucent
synthetic cover

Outside colour



Inside colour



Q P0154



works with
BEGA Smart

Size

Ø 215 mm

Luminaire luminous flux

1860–1970 lm

Connected wattage

27.5 W

Colour temperature

3000 K

LED module

Colour rendering index

CRI >90

Power supply unit

DALI controllable

Material

translucent synthetic cover
with optical texture

Outside colour



Inside colour



Q P0243



Page 263



Page 175

STUDIO LINE

Cylindrical system pendant luminaires

Shielded pendant luminaires that create a fascinating lighting atmosphere. Cylindrical luminaires for a variety of applications in interior design. They are part of the STUDIO LINE luminaire series and boast both economical and reliable LED technology as well as a fascinating interplay of the different materials.

The metallic inside colours contrast beautifully with the exterior finish – especially when illuminated.

Choose the luminaires to match your interior theme – from six colour combinations in various sizes and light outputs.

Choose the relevant smart version of the canopy if you want to control your luminaire via the BEGA Smart app.

You will find an overview of matching system components on Page 195.

STUDIO LINE finishes

Velvet white or velvet black outside colour

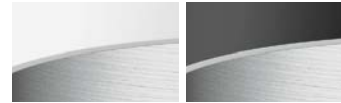

Inside colour matt aluminium



Inside colour matt brass



Inside colour matt copper





works with
BEGA Smart

STUDIO LINE
System pendant luminaires

Size

H 330 · 450 mm
Ø 100 · 140 mm

Luminaire luminous flux
685 – 1810 lm

Connected wattage
18.2 · 28.8 W

Colour temperature
3000 K

LED module

Colour rendering index
CRI > 90

Power supply unit
DALI controllable

Outside colour



Inside colour



Q P 0258

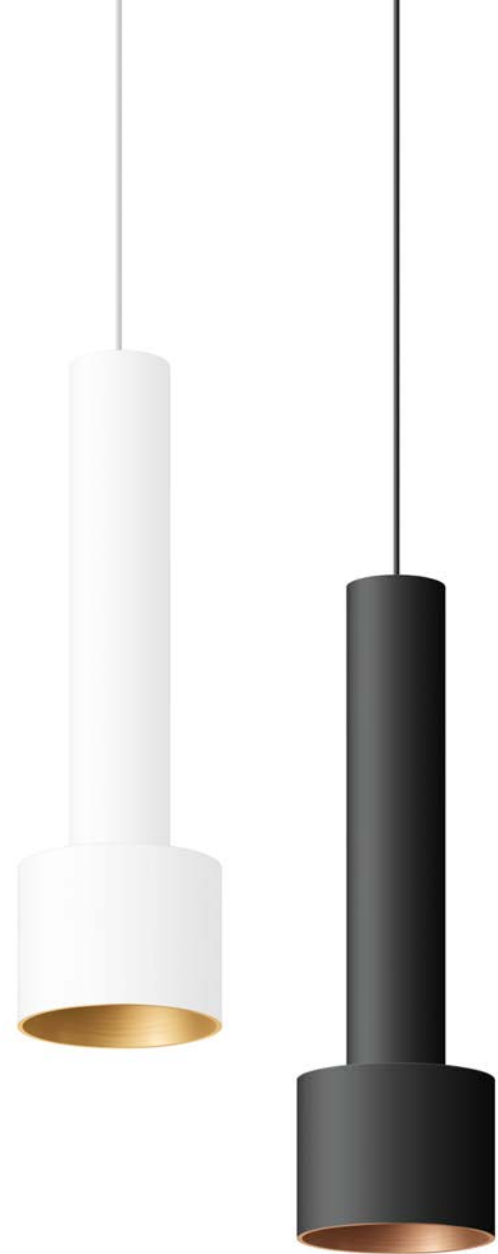
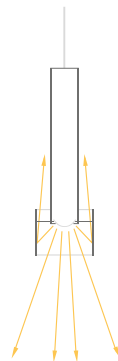



Size

H 400 · 500 mm
 Ø 50 · 60 mm

Luminaire luminous flux
 305 – 480 lm

Connected wattage
 10.0 · 13.0 W

Colour temperature
 3000 K

LED module

Colour rendering index
 CRI > 90

Power supply unit
 on/off

Outside colour



Inside colour



Q P 0257



Size

H 190 · 250 mm
 Ø 80 · 100 mm

Luminaire luminous flux
 335 – 600 lm

Connected wattage
 10.0 · 13.0 W

Colour temperature
 3000 K

LED module

Colour rendering index
 CRI > 90

Power supply unit
 on/off

Outside colour



Inside colour



Q P 0200

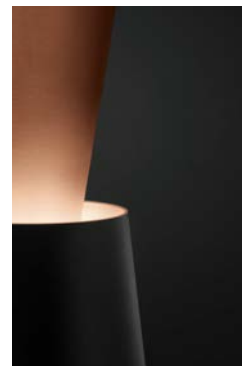

STUDIO LINE

System pendant luminaires with additional light emission upwards

The luminaires of the STUDIO LINE series are characterised by the contrast between their outer finish and metallic inside colour, which is a particularly prominent feature of these pendant luminaires.

The metallic luminaire housing shields the downward directed light. Part of the light is emitted upward, highlighting the shape of the luminaire and additionally emphasising the interplay of the surfaces.

Luminaires for many interior design applications that offer economical and reliable LED technology as well as a fascinating interplay of various materials.

Choose the luminaires to match your interior theme – from four colour combinations in various sizes and light outputs.

Choose the relevant smart version of the canopy if you want to control your luminaire via the BEGA Smart app.

You will find an overview of matching system components on Page 195.



works with
BEGA Smart

Size
Ø 190 · 230 mm

Luminaire luminous flux
605 – 1160 lm

Connected wattage
18.0 · 27.8 W

Colour temperature
3000 K

LED module

Colour rendering index
CRI > 90

Power supply unit
DALI controllable

Outside colour



Inside colour



Q P0144



works with
BEGA Smart

Size
Ø 160 · 195 mm

Luminaire luminous flux
550 – 1060 lm

Connected wattage
18.0 · 27.8 W

Colour temperature
3000 K

LED module

Colour rendering index
CRI > 90

Power supply unit
DALI controllable

Outside colour



Inside colour



Q P0176



STUDIO LINE

System pendant luminaires

Expressive material diversity can manifest in various ways: the focus is directed towards the material not only by the contrast of colours, but also by the minimalist shape. The metallic inner colours reveal their true beauty when illuminated.

These pendant luminaires in various sizes and impressive light outputs create a highly uniform and attractive lighting atmosphere – when used as a single luminaire or arranged in groups.

Luminaires that feature economical and reliable LED technology.

Choose from eight colour combinations to match the luminaires to your interior.

Choose the relevant smart version of the canopy if you want to control your luminaire via the BEGA Smart app.

You will find an overview of matching system components on Page 195.

STUDIO LINE finishes

Velvet white or velvet black outside colour



Inside colour white



Inside colour matt aluminium



Inside colour matt brass



Inside colour matt copper





works with
BEGA Smart

STUDIO LINE
System pendant luminaires

Size
Ø 350 · 450 · 600 mm

Luminaire luminous flux
975 – 4220 lm

Connected wattage
15.5 – 47.3 W

Colour temperature
3000 K

LED module

Colour rendering index
CRI >90

Power supply unit
on/off · DALI controllable

BEGA Thermal Management®

Material
White, translucent
synthetic cover

Outside colour



Inside colour



Q P 0132



Size
Ø 260 · 360 · 430 mm

Luminaire luminous flux
1010–4000 lm

Connected wattage
15.5–47.3 W

Colour temperature
3000 K

LED
LED module

Lamp
E 27 LED lamp included

Colour rendering index
CRI >80 · >90

Power supply unit
on/off · DALI controllable

BEGA Thermal Management®

Material
White, translucent
synthetic cover

Outside colour



Inside colour



Q P0180



Page 81



Page 84



Page 229



STUDIO LINE PENDANT LUMINAIRES

Exceptional form

The transition between luminaire and sculptural element is fluid – this model series goes far beyond just function. It is a luminaire and light object in one and enchants with its shape and the materials used. A fascinating group of pendant luminaires that redefines creativity in interior design.

The luminaires are completely shielded on two sides.

The range of available sizes opens up a multitude of options for attractive installations with distinctive character in conjunction with the matching wall luminaires.

The luminaire canopy can be rotated to allow free orientation of the luminaires during installation.

The luminaires of the STUDIO LINE series feature a fascinating interplay of various materials.

The metallic inside colours contrast beautifully with the exterior finish – especially when illuminated.





Page 168

Size
Ø 280 · 400 mm

Luminaire luminous flux
460 – 1125 lm

Connected wattage
16.3 · 32.6 W

Colour temperature
3000 K

LED module

Colour rendering index
CRI >90

Power supply unit
DALI controllable

Material
White, translucent
synthetic cover

Outside colour



Inside colour



Q P0177



STUDIO LINE PENDANT LUMINAIRES

Light emission on two sides

Pendant luminaires define the lighting atmosphere in the room: in these three model series, the light emission on two sides additionally brightens the ceiling. The resulting indirect, yet uniform illumination is particularly attractive to the human eye.

These powerful luminaires are available in various sizes and are DALI controllable, enabling the adjustment of the degree of illuminance to match the relevant requirements.

The metal shields of the two higher versions ensure that the light is fully shielded laterally. The version with the lower metal shield allows the light to also be emitted laterally into the room.

These luminaires are part of the STUDIO LINE series and feature economical and reliable LED technology as well as a fascinating mix of materials.

The metallic inside colours contrast beautifully with the exterior finish – especially when illuminated.

Choose a colour combination for your luminaires to match your interior theme.

STUDIO LINE finishes

Velvet white or velvet black outside colour

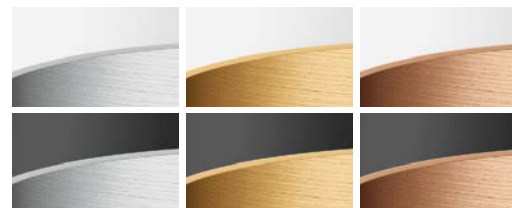

Inside colour matt aluminium

Inside colour matt brass

Inside colour matt copper

Depending on the inside colour of the luminaire, the light will have a neutral or warm tint.







STUDIO LINE
Pendant luminaires

Size
Ø 310 · 400 mm

Luminaire luminous flux
2110–3715 lm

Connected wattage
38.0 · 48.0 W

Colour temperature
3000 K

LED module

Colour rendering index
CRI > 90

Power supply unit
DALI controllable

BEGA Thermal Management®

Material
White, translucent
synthetic cover

Outside colour



Inside colour



Page 211



Page 263

Q P 0202



Page 84

Size
 Ø 300 · 400 · 475 mm

Luminaire luminous flux
 1830–6870 lm

Connected wattage
 26.7–94.0 W

Colour temperature
 3000 K

LED module

Colour rendering index
 CRI >90

Power supply unit
 DALI controllable

BEGA Thermal Management®

Material
 White, translucent
 synthetic cover

Outside colour



Inside colour



Q P0232



Page 85

Size
 Ø 300 · 400 · 475 mm

Luminaire luminous flux
 2135–7700 lm

Connected wattage
 26.7–94.0 W

Colour temperature
 3000 K

LED module

Colour rendering index
 CRI >90

Power supply unit
 DALI controllable

BEGA Thermal Management®

Material
 White, translucent
 synthetic cover

Outside colour



Inside colour



Q P0256



STUDIO LINE LARGE-AREA PENDANT LUMINAIRES

Light in other dimensions

STUDIO LINE pendant luminaires that not only feature unusual dimensions and impressive light outputs, but also shine with the quality of their overall finish and the materials used.

These are luminaires for large interior spaces – they will add character to individual areas or entire halls.

Choose between luminaires with fixed or variable colour temperature (tunable white).

By adjusting the colour temperature, the lighting can be perfectly adapted to your requirements or the desired mood.

Colour temperatures between 2700 and 6500 Kelvin are available, covering the colour temperature range perceived as ideal for the human eye.



**Size**

Ø 1000 · 1300 mm

Luminaire luminous flux

10 470 – 16 200 lm

Connected wattage

101.0 – 144.0 W

Colour temperature

3000 K or
Tunable white 2700 – 6500 K

LED module

Colour rendering index
CRI > 90

Power supply unit

DALI controllable

BEGA Thermal Management®**Material**

White, translucent
synthetic cover

Outside colour**Inside colour**

Q P 0208



Page 87



2700 Kelvin

3000 Kelvin

4000 Kelvin

6500 Kelvin

Colour temperature control with tunable white

In luminaires with variable colour temperature, the light colour is **infinitely variable**. The spectrum begins with a warm white light colour at 2700 Kelvin, which is similar to the light emitted by the conventional incandescent light bulb.

Neutral white light at 4000 Kelvin is traditionally used for office lighting. 6500 Kelvin generate cold white light, similar to daylight at noon.

Please visit www.bega.com/tunable-white for more information about tunable white

Large-area pendant luminaires

PLANETA and MAXIMA – two large-area pendant luminaires that offer creative design options in many areas of interior architecture.

PLANETA pendant luminaires emit their light downward. They are available in two diameters and feature a small projection. The safety glass is frosted white on the inside and precisely set in a metal frame and distributes the light of the LED uniformly across the illuminated area. These luminaires are DALI controllable to perfectly coordinate the light with the relevant lighting situation.

MAXIMA pendant luminaires similarly feature two diameters and a light output of over 17 000 lumen. They emit their light primarily downward, are DALI controllable and available optionally with fixed or variable colour temperature (tunable white). By adjusting the colour temperature within the range of 2700 and 6500 Kelvin, you will be able to perfectly match the illumination to your own requirements of brightness and mood.





PLANETA

Large-area pendant luminaires

Size

Ø 500 · 750 mm

Luminaire luminous flux

6150 · 10270 lm

Connected wattage

74.0 · 116.0 W

Colour temperature

3000 K · 4000 K

LED module

Colour rendering index

CRI >90

Power supply unit

DALI controllable

BEGA Thermal Management®

Material

Safety glass, inside white

Finish



Q P0221



Page 108



MAXIMA

Large-area pendant luminaires

Tunable white

Size

Ø 1000 · 1300 mm

Luminaire luminous flux

12 365 – 17 295 lm

Connected wattage

101.0 – 144.0 W

Colour temperature

3000 K · 4000 K or
Tunable white 2700 – 6500 K

LED module

Colour rendering index

CRI > 90

Power supply unit

DALI controllable

BEGA Thermal Management®

Material

White, translucent
synthetic cover

Q P 0196



Page 109

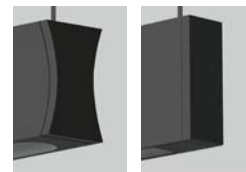

PENDANT LUMINAIRES

Linear light in two directions

Two new STUDIO LINE pendant luminaires in unusual lengths that emit their light upward and downward.

Both luminaires are available in three lengths and colours as well as with various light outputs. In terms of shape, they only differ in their profile.

The pendant luminaire is available in two versions: with straight lines and a rectangular cross-section, or with concave lateral surfaces. In both versions, the light is distributed softly and uniformly by a silicone diffuser embedded in the luminaire profile.

These luminaires are particularly well suited for illuminating long, narrow eating areas or counter surfaces.

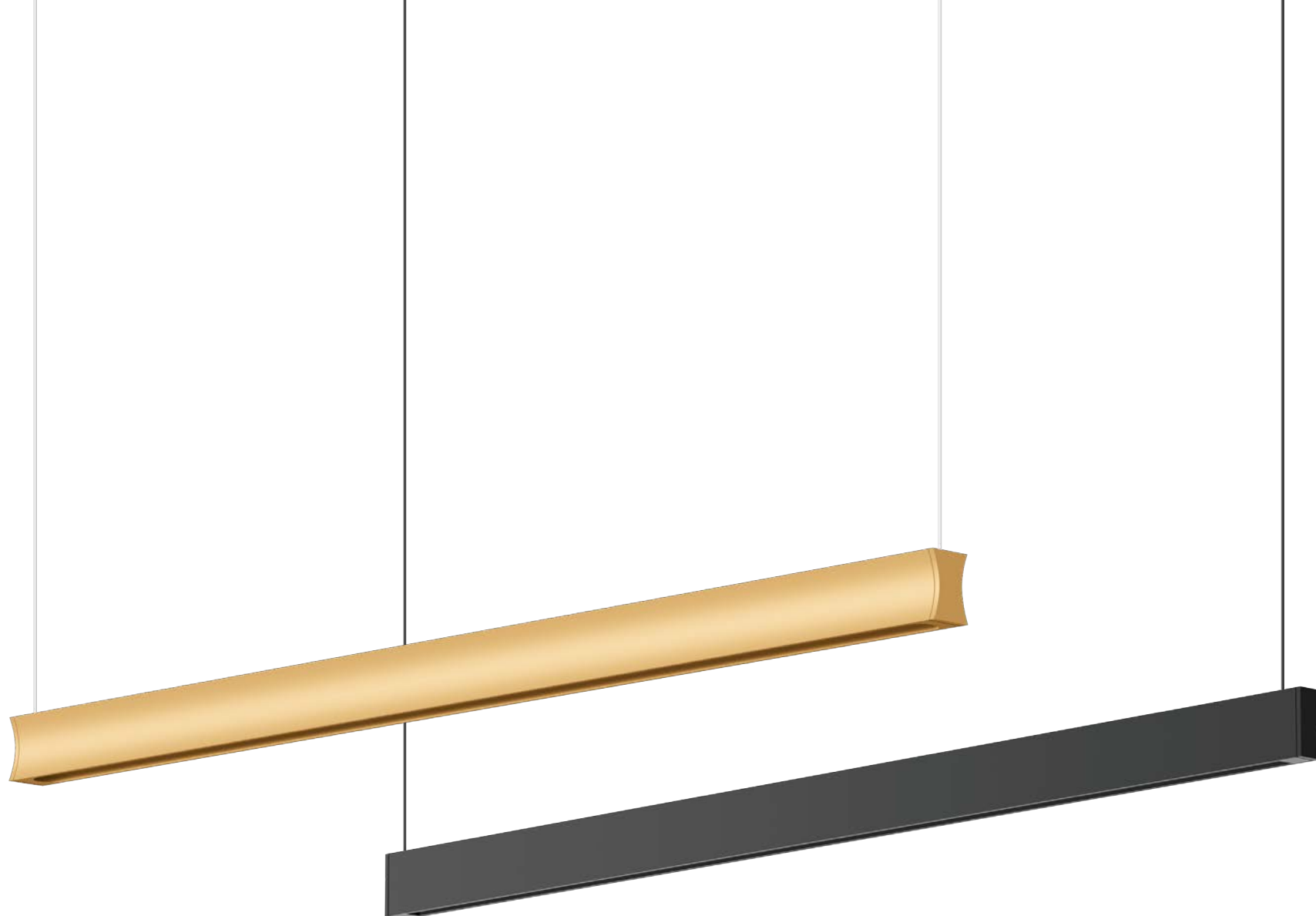

Length
770 · 1170 · 1870 mm

Luminaire luminous flux
1340–6425 lm

Connected wattage
30.8–79.0 W

Colour temperature
3000 K

LED module

Colour rendering index
CRI >90

Power supply unit
DALI controllable

BEGA Thermal Management®

Material
Silicone light diffuser

Luminaire colours



Q P0157 · P0170



A silicone diffuser distributes the light of the LED upward and downward in both luminaire versions.

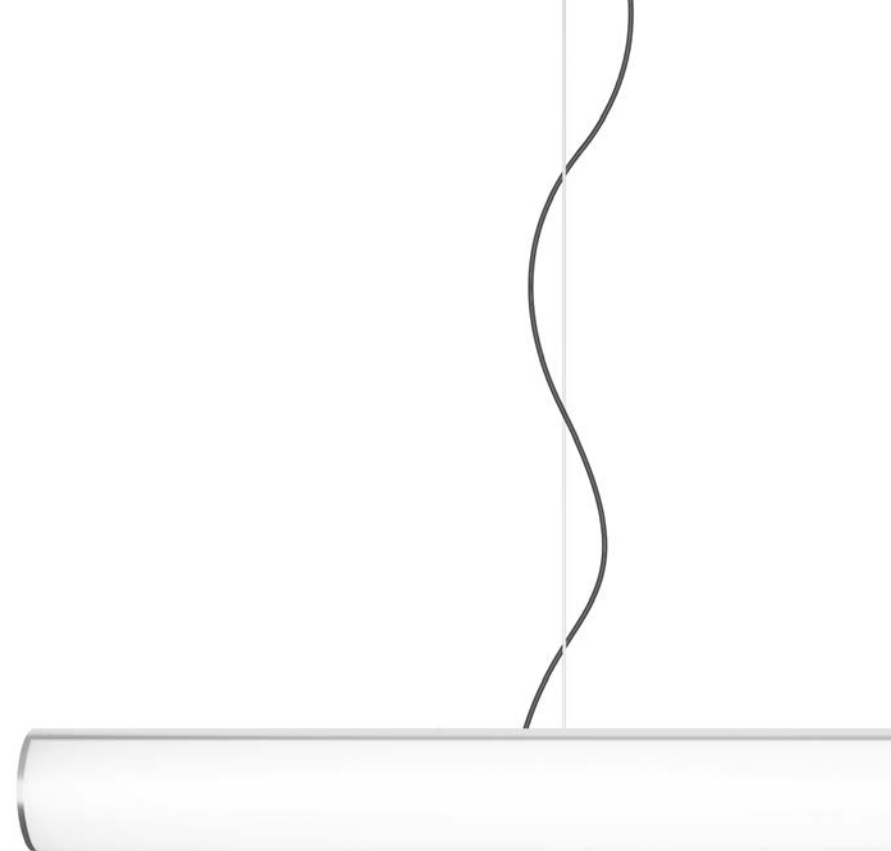

LINEARA PENDANT LUMINAIRES

Light with a memorable presence

Light becomes the primary architectural element: with a diameter of just 80 millimetres and luminaire lengths of one, two or three metres, the pendant luminaires of the LINEARA series with unshielded light offer a broad spectrum of possible applications. Their high light output with DALI controllable power supply units make them eye-catching light objects for a variety of light design projects.

Whether as single luminaires or in rows, they command attention with their shape and performance characteristics, creating impressive indoor installations.



Page 112

Length

1000 · 2000 · 3000 mm

Luminaire luminous flux

7960–23 820 lm

Connected wattage

73.6–218.0 W

Colour temperature

3000 K · 4000 K

LED module

Colour rendering index

CRI > 90

Power supply unit

DALI controllable

BEGA Thermal Management®

Material

White, translucent
synthetic cover

Finishes



Q P0121



Extra flat large-area pendant luminaires

The pendant luminaires – just like the matching ceiling luminaires – are ideal for the glare-free illumination of workplaces in compliance with DIN EN 12464-1. The luminaires with their high-quality finish and a frame height of just eleven millimetres astound with excellent precision. With a design consisting of micro-structured and light-directing layers to exactly match our LED modules, their optical system ensures glare-free and comfortable light at the workplace.

Seventy percent of the light is emitted directly onto the area to be illuminated, while 30 percent make up the indirect portion of light emitted upward for optimal visual comfort.



70 % direct light,
30 % indirect light

Frame height 11 mm

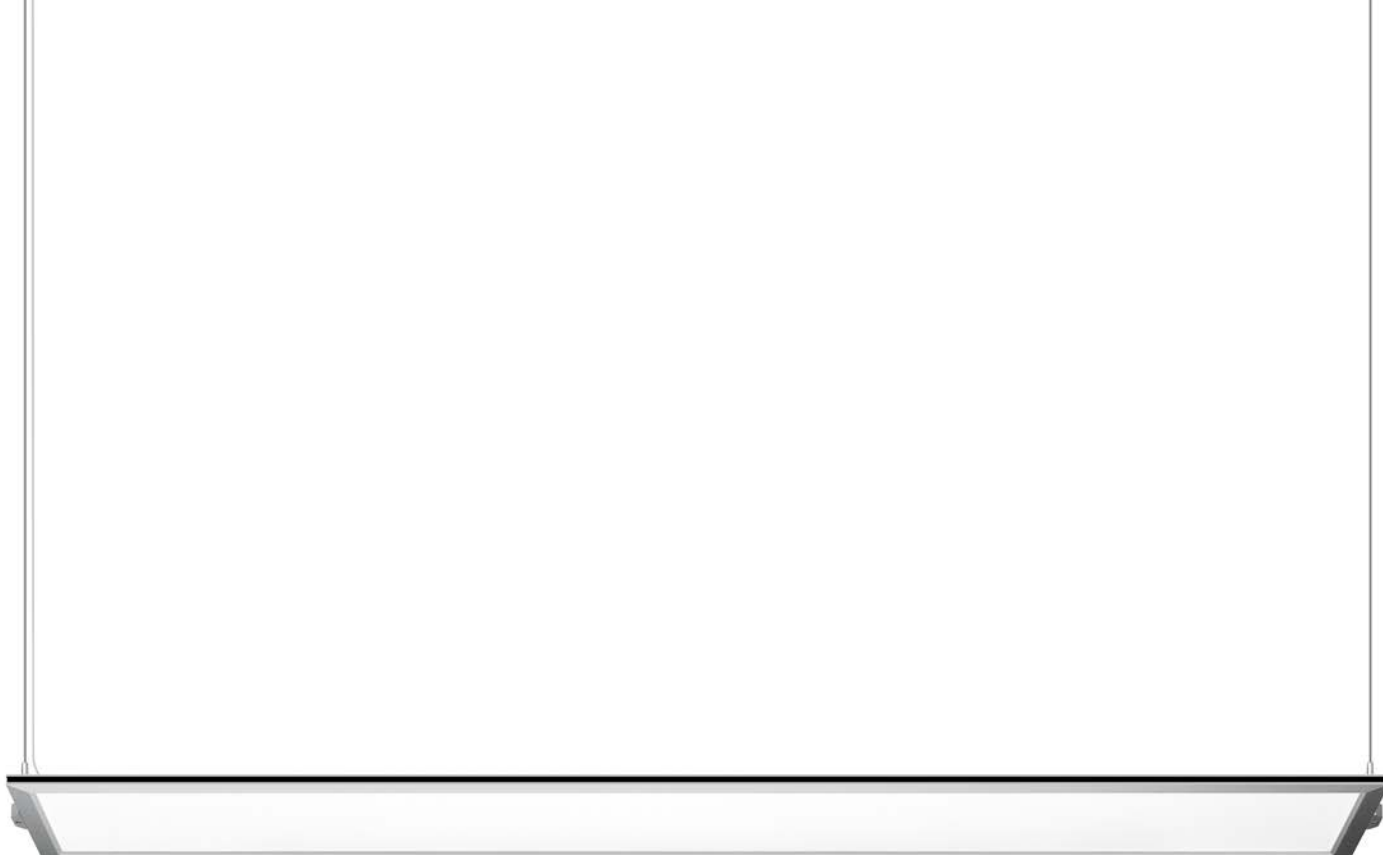

Page 75

Length
1565 mm

Luminaire luminous flux
7005 lm

Connected wattage
60.0 W

Colour temperature
3000 K · 4000 K

LED module

Colour rendering index
CRI >90

Power supply unit
DALI controllable

BEGA Thermal Management®

Finish



Q P0108





LARGE-AREA PENDANT LUMINAIRES

Impressive chandeliers

Our chandeliers are a contemporary interpretation of the historical chandeliers that have been used for centuries to illuminate rooms in a particularly festive manner. With their size and light effects, these luminaires create an impressive effect both during the day and when illuminated.

Prestigious, festive light – for exclusive private rooms as well as grand, stylish architecture.

We offer these luminaires in three different light distributions and three sizes to fulfil your lighting design requirements.

Depending on your particular planning needs, choose the appropriate light distribution and version to create the desired lighting atmosphere. All versions of the chandeliers emit their light both upwards and downwards.

We can also deliver custom chandeliers with upward and downward directed light that can be controlled separately.

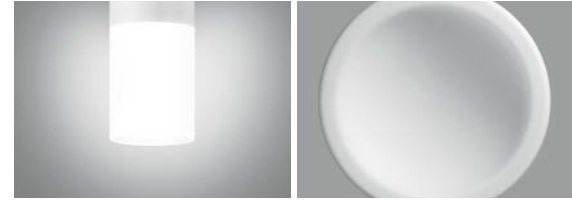

Chandeliers with opal glass are luminaires with glass elements made of three-ply opal glass and closed at the top and bottom. The wide light is evenly and softly distributed upwards and downwards in the room. The long, cylindrical luminaire bodies with their frosted, hand-blown luminaire glass create an attractive, uniform brightness and a lighting atmosphere reminiscent of festively decorated halls.



Chandeliers with crystal glass are luminaires with partially frosted, thick-walled crystal glass closed at the top and bottom. Integrated reflectors deflect the light upwards and downwards into the room in a very wide beam.

The hand-crafted crystal glass is a key component of the luminaires' festive appearance and creates a brilliant, multi-faceted play of light.



Chandeliers with BEGA Hybrid Optics® are downlights with very wide beam light distribution. These optics take advantage of both the lens and the reflector technology. This results in highly efficient, low-loss optical systems that are closed at the top and bottom and offer optimal glare suppression and very compact dimensions. Chandeliers with this lighting technology stand out due to their very high luminous efficiency and the excellent quality of their lighting.

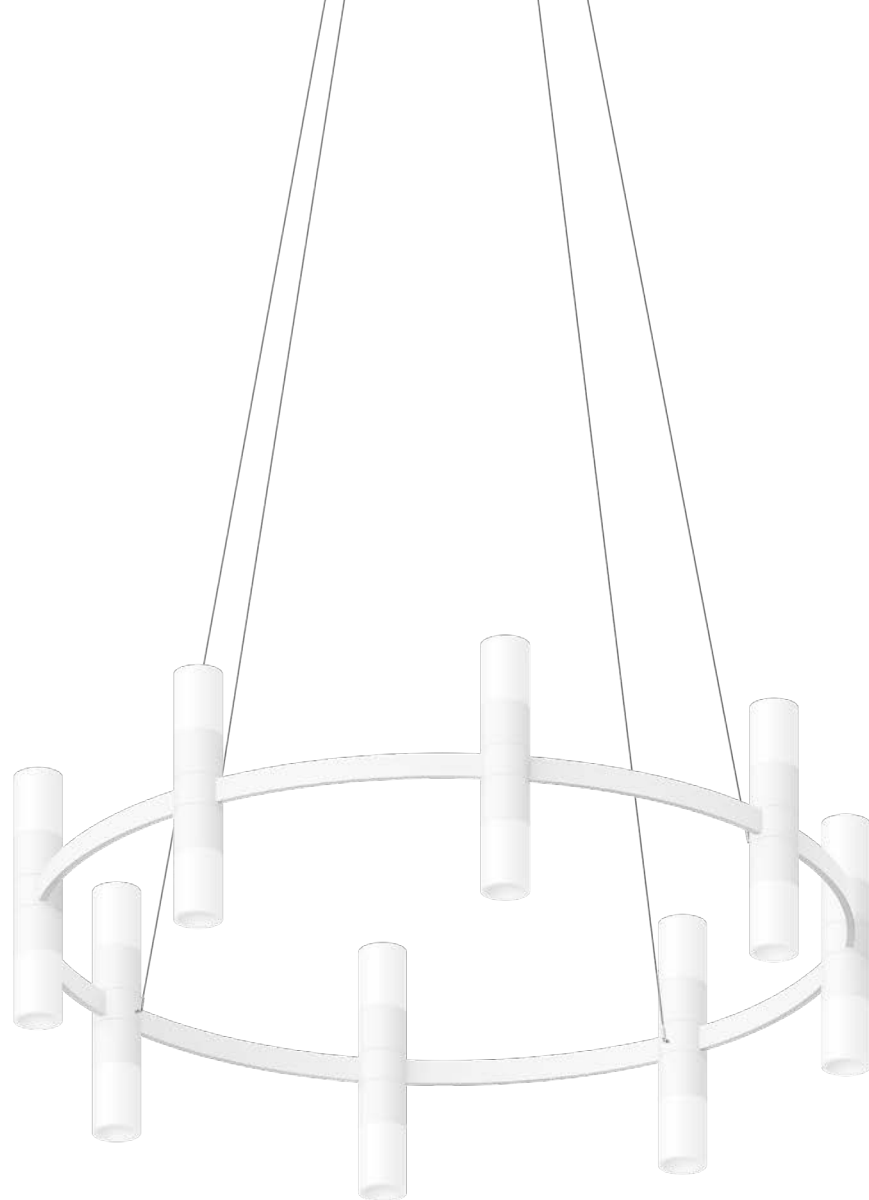

LARGE-AREA PENDANT LUMINAIRES
Chandeliers



Custom-made chandelier: unidirectional light

Size
Ø 1550 · 2000 · 3000 mm

Luminaire luminous flux
9540 – 19 080 lm

Connected wattage
120.0 – 240.0 W

Colour temperature
3000 K · 4000 K

LED module

Colour rendering index
CRI > 90

Power supply unit
DALI controllable

Optical system
BEGA Constant Optics®

BEGA Thermal Management®

Material
Three-ply opal glass

Q P 0231

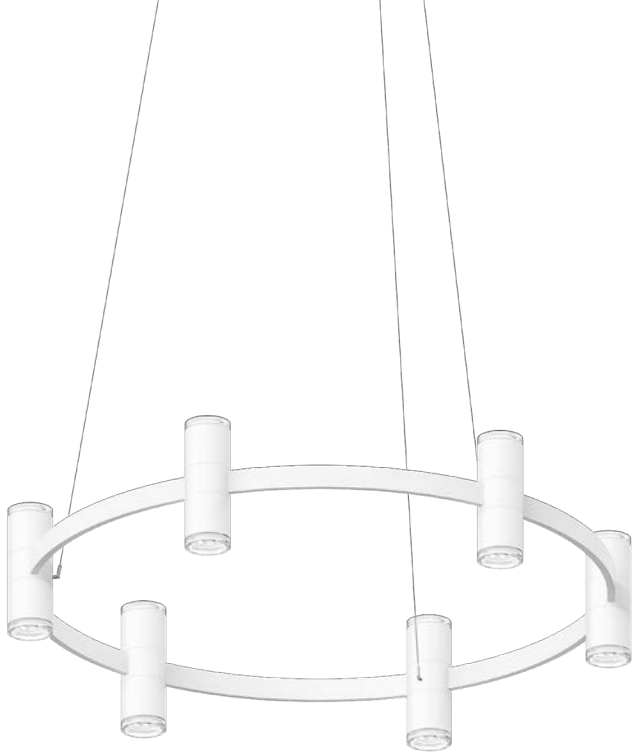

Size
 Ø 1550 · 2000 · 3000 mm

Luminaire luminous flux
 10 280 – 20 560 lm

Connected wattage
 120.0 – 240.0 W

Colour temperature
 3000 K · 4000 K

LED module

Colour rendering index
 CRI >90

Power supply unit
 DALI controllable

Optical system
 BEGA Constant Optics®

BEGA Thermal Management®

Material
 Crystal glass

Q P 0209

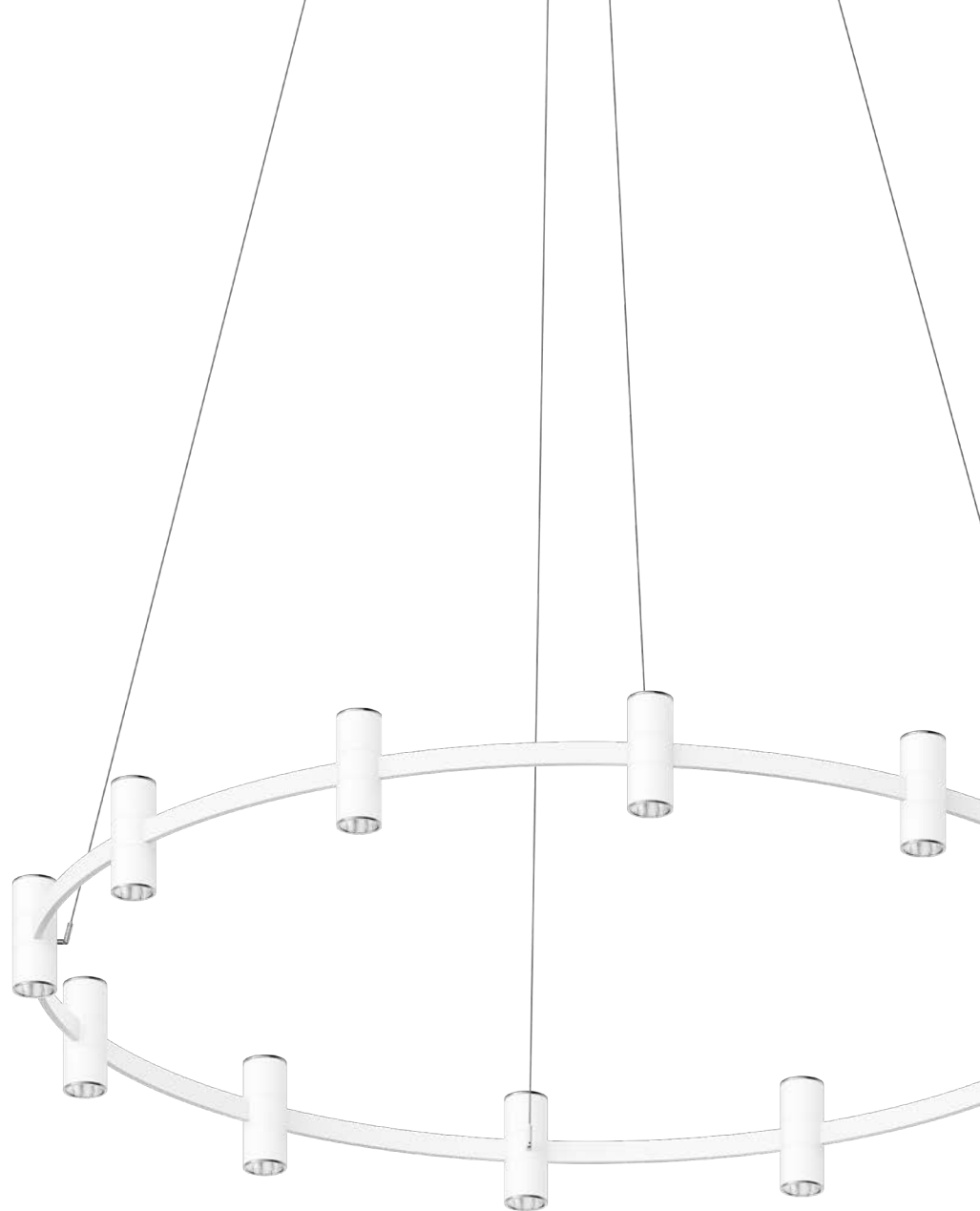

Size
 Ø 1550 · 2000 · 3000 mm

Luminaire luminous flux
 12 840 – 25 680 lm

Connected wattage
 120.0 – 240.0 W

Half beam angle
 74°

LED module

Colour temperature
 3000 K · 4000 K

Colour rendering index
 CRI >90

Power supply unit
 DALI controllable

Optical system
 BEGA Hybrid Optics®

BEGA Thermal Management®

Material
 Safety glass

Q P 0203

STUDIO LINE finishes

Velvet white or velvet black outside colour



Inside colour matt aluminium



Inside colour matt brass



Inside colour matt copper

STUDIO LINE LARGE-AREA PENDANT LUMINAIRES

Chandeliers reinvented

The STUDIO LINE chandeliers are luminaires that add character to rooms during the day simply with their dimensions. Their true brilliance, however, is revealed when they are lit. That is when their metallic inside colours contrast beautifully with the exterior finish to develop their full beauty.

Their high luminous intensity makes them highly visible objects for many lighting requirements in large to very large rooms.

Depending on the model, the STUDIO LINE chandeliers emit their light upward and downward or only downward. Choose a colour combination for your luminaires to match your interior theme.



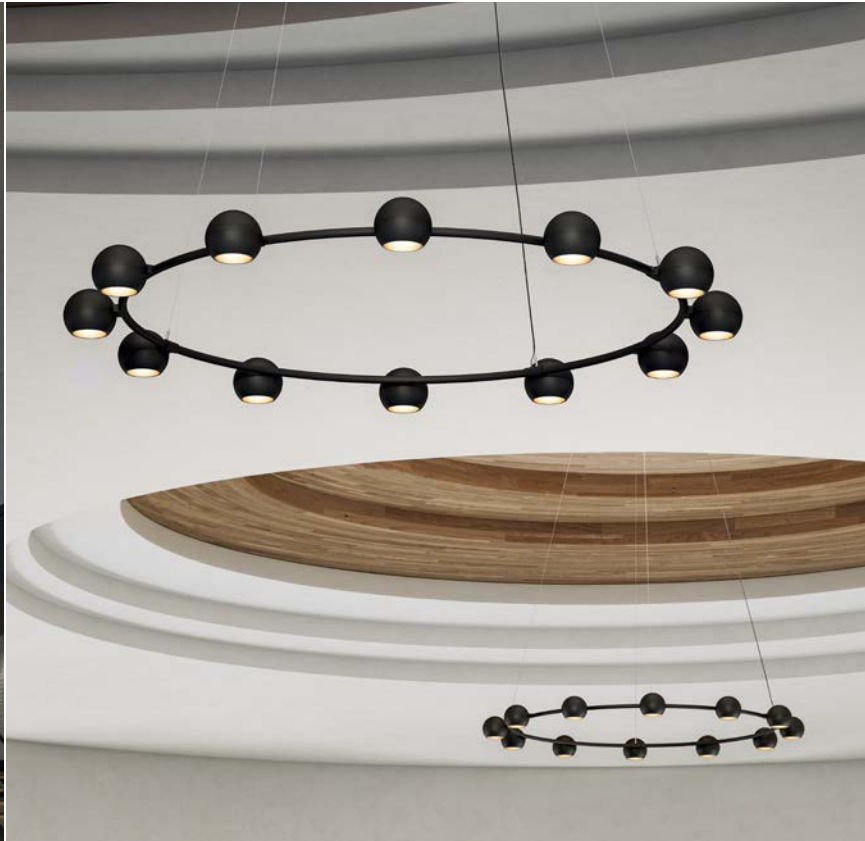



STUDIO LINE LARGE-AREA PENDANT LUMINAIRES

Chandeliers

Size
Ø 1550 · 2000 · 3000 mm

Luminaire luminous flux
9680–21 960 lm

Connected wattage
120.0–240.0 W

Colour temperature
3000 K

LED module

Colour rendering index
CRI > 90

Power supply unit
DALI controllable

Optical system
BEGA Constant Optics®

BEGA Thermal Management®

Material
Safety glass

Outside colour



Inside colour



Q P0146



Size
Ø 2000 mm

Luminaire luminous flux
17 880 – 19 560 lm

Connected wattage
234.0 W

Colour temperature
3000 K

LED module

Colour rendering index
CRI > 90

Power supply unit
DALI controllable

BEGA Thermal Management®

Outside colour



Inside colour



Q P 0225



Custom-made product for permanent installation

TABLE LUMINAIRES

Infinitely adjustable light

The infinitely adjustable reading light is useful virtually anywhere in our daily lives – in libraries, conference rooms or at the desk in the home office. The design and technology of these luminaires enable the light to be directed in various directions. The light emission is shielded in one direction and can be infinitely adjusted along the luminaire axis. The reading light is glare-free, but still offers the necessary luminous energy for the area to be illuminated.

These luminaires uniquely combine functionality and aesthetics.

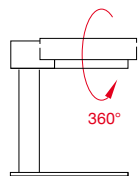
**Size**

H 330 mm
W 285 mm

Luminaire luminous flux
420 lm

Connected wattage
8.2 W

Colour temperature
3000 K · 4000 K

LED module

Colour rendering index
CRI > 90

Electrical connection
Connecting cable with type F/E mains plug
Integrated power switch

BEGA Thermal Management®

Material
Three-ply opal glass

Finish



Q P 0122



UNSHIELDED TABLE LAMPS

Modern classics

The appearance of these table lamps is defined by the classic cylinder shape: it relies on a combination of luminaire glass made of satin matt, hand-blown opal glass and precise metal fittings with a selection of finishes.

High-quality and energy-efficient luminaires with various dimensions for many areas of application in hotels, restaurants and private environments, presented as timelessly beautiful lighting tools for stylish interiors.

The luminaires are optionally available with an LED module or LED lamps for E 14 and E 27 screw bases.







Unshielded table lamps

Size

H 280 · 380 · 480 mm
Ø 70 · 94 · 110 mm

Luminaire luminous flux

350 – 1120 lm

Connected wattage

4.5 – 12.0 W

Colour temperature

2700 K · 3000 K · 4000 K

LED

LED module

Lamp

E14 / E27 LED lamp included

Colour rendering index

CRI >80 · >90

Electrical connection

Connecting cable with
Type F/E mains plug
Switch in the luminaire base

BEGA Thermal Management®**Material**

Three-ply opal glass

Finish

Q P0272

**Size**

H 370 mm
Ø 165 mm

Luminaire luminous flux

1120 · 1360 lm

Connected wattage

12.0 · 14.9 W

Colour temperature

2700 K · 3000 K · 4000 K

LED

LED module

Lamp

E 27 LED lamp included

Colour rendering index

CRI >80 · >90

Electrical connection

Connecting cable with Type F/E
mains plug · Touch-controlled
dimmer in the luminaire base

BEGA Thermal Management®**Material**

Three-ply opal glass

Finish

Q P0240

**Size**

H 220 · 260 mm
Ø 180 · 220 mm

Luminaire luminous flux

650–1370 lm

Connected wattage

7.0–14.7 W

Colour temperature

2700 K · 3000 K · 4000 K

LED

LED module

Lamp

E 27 LED lamp included

Colour rendering index

CRI >80 · >90

Electrical connection

Connecting cable with Type F/E
mains plug · Touch-controlled
dimmer in the luminaire base

BEGA Thermal Management®**Material**

Three-ply opal glass

Finish

Q P0109



Custom-made product for permanent installation

UNSHIELDED TABLE AND FLOOR LAMPS

Uncompromising form

When the same design elements are shared by table lamps and floor lamps, then the combination possibilities become virtually endless.

Here, the classic cylinder shape and the stainless steel surfaces create a winning combination – perfect for spaces, where coordinated lighting design is desired.

The perfectly matched proportions and the high material quality of the luminaire housings with their luxurious finishes are just as impressive as the high-end, three-ply opal glass, which distributes the light attractively and uniformly.

Luminaires of timeless beauty – high-quality illumination for stylish rooms.



Unshielded Table and floor lamps

Size

H 625 · 1560 mm
Ø 220 · 350 mm

Luminaire luminous flux

650 · 4250 lm

Connected wattage

7.0 · 48.0 W

Colour temperature

2700 K · 3000 K

Lamp

E 27 LED lamp included

Colour rendering index

CRI >80

Electrical connection

Connecting cable with type F/E mains plug
Cord dimmer

Material

Three-ply opal glass

Finish

Q P0142 · P0162



Size

H 720 · 1700 mm
Ø 175 · 290 mm

Luminaire luminous flux

630 · 1120 lm

Connected wattage

7.0 · 12.0 W

Colour temperature

2700K · 3000K

Lamp

E 27 LED lamp included

Colour rendering index

CRI >80

Electrical connection

Connecting cable with type F/E mains plug
Cord-operated toggle switch · Foot dimmer

Material

Three-ply opal glass

Finish

Q P0174 · P0260



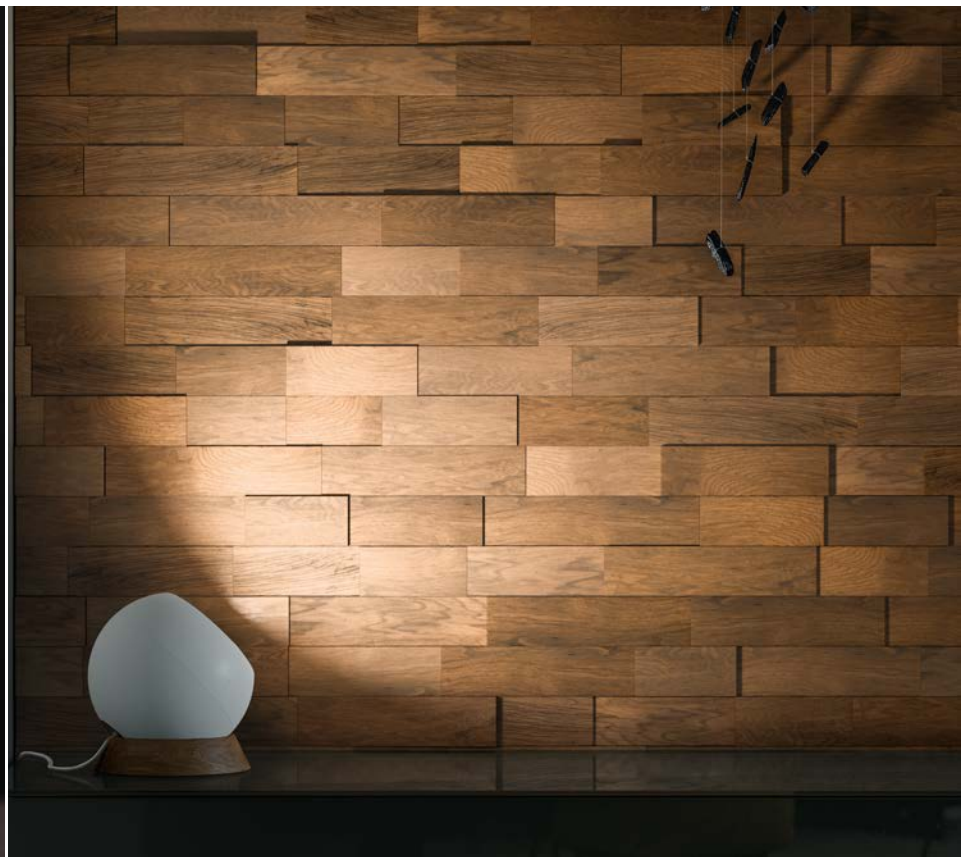

STUDIO LINE

Versatile table lamp

This table lamp is suitable for a variety of applications: the spherical spotlight sits unmounted on its wooden base and can be positioned freely. It can therefore be used for an endless variety of lighting situations. Wall and ceiling surfaces can be highlighted just as effectively as pictures or objects.

These versatile luminaires create a pleasant lighting atmosphere with their soft light and set accents in the room. They are part of the STUDIO LINE luminaire series and feature economical and reliable LED technology as well as a fascinating interplay of metal finishes.

When illuminated, the metallic inside colours reveal their true beauty. There are two luminaire sizes to choose from, with 18 colour and base combinations each, to find a luminaire to perfectly match your interior theme.



Natural oak

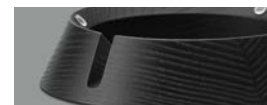

Ash wood with black varnish



Ash wood with white varnish



Page 78



Page 78



Page 208



Size
Ø 140 · 190 mm

Luminaire luminous flux
720 – 1070 lm

Connected wattage
10.0 · 13.5 W

Colour temperature
3000 K

LED module

Colour rendering index
CRI >90

Electrical connection
Connecting cable with
Type F/E mains plug
Cord dimmer

Optical system
BEGA Constant Optics®

BEGA Thermal Management®

Material
Safety glass

Outside colour



Inside colour



Q P0219



STUDIO LINE TABLE AND FLOOR LAMPS

Light emission on two sides

Table and floor lamps that emit their shielded light downward and upward. The light emission on two sides ensures a particularly attractive and uniform illumination of the room by brightening the ceiling surface.

Luminaires in various sizes and light outputs for a variety of applications in public and private spaces.

Luminaires from the STUDIO LINE luminaire series feature economical and reliable LED technology as well as a fascinating interplay of different materials. The metallic inside colours contrast beautifully with the exterior finish – especially when illuminated.

Choose a colour combination for your luminaires to match your interior theme.





STUDIO LINE:

Depending on the inside colour of the luminaire, the light will have a neutral or warm tint.



STUDIO LINE

Table and floor lamps



Size

H 1835 mm
Ø 300 · 400 mm

Luminaire luminous flux

2275 – 4150 lm

Connected wattage

27.0 · 45.2 W

Colour temperature

3000 K

LED module

Colour rendering index

CRI > 90

Electrical connection

Connecting cable with
Type F/E mains plug
Touch-controlled dimmer

Material

White, translucent
synthetic cover

Outside colour



Inside colour



Q P0161





Page 175



Page 211



Page 226



Size

H 500 · 1400 mm
Ø 215 mm

Luminaire luminous flux

1295 · 1355 lm

Connected wattage

19.5 W

Colour temperature

3000 K

LED module

Colour rendering index

CRI >90

Electrical connection

Connecting cable with
Type F/E mains plug
Touch-controlled dimmer

Material

Translucent synthetic cover
with optical texture

Outside colour



Inside colour



Q P0229

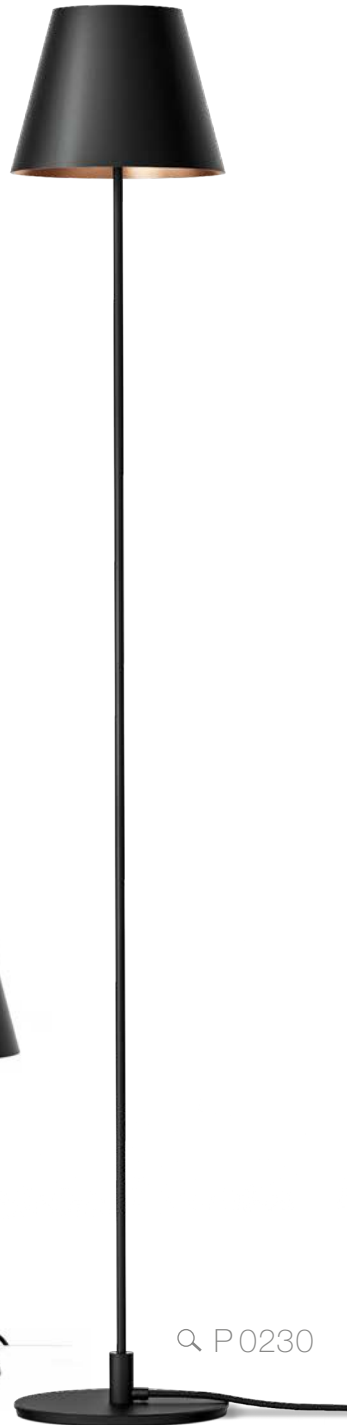

Q P0230



Size

H 1500 · 1700 mm
Ø 310 · 400 mm

Luminaire luminous flux

2100–2950 lm

Connected wattage

39.0 · 49.0 W

Colour temperature

3000 K

LED module

Colour rendering index

CRI >90

Electrical connection

Connecting cable with
Type F/E mains plug
Foot dimmer

Material

White, translucent
synthetic cover

Outside colour



Inside colour



Q P0267

Imprint

Editors: BEGA, Menden
Printed by LUC, Greven
Lithography: RGI, Dortmund

Concept, design and photography are the joint work of our company's designers.

BEGA Indoor Luminaire Catalogue 64 is available in the following languages: Dutch, English, French, German, Italian, and Spanish.

The publication of this catalogue means that our indoor luminaires catalogue 63 is no longer valid.

All deliveries, services and offers provided by BEGA to companies are made exclusively on the basis of our terms of delivery, which can be found at: www.bega.com/terms-of-delivery

BEGA Gantenbrink-Leuchten KG
P.O. Box 3160 · 58689 Menden
Hennenbusch 1 · 58708 Menden
Germany
Phone +49 2373 966-0
www.bega.com · export@bega.com

We reserve the right to make changes in design and technology.
Colours may vary in printing.

© BEGA · 2022

We would like to thank the following for permission to publish photos:

caia image · Alamy Stock Foto | Felix Speller · CAKE Architecture, London | David Frutos, Murcia | David Flynn, Australian Business Traveller | EWE Arena, Oldenburg | Hochfarbe, Schwerte | Hufton+Crow, Hertford | Jens Görlich, Frankfurt | Jörg Hempel, Aachen | Juniwind Architektur, Dornbirn | Keidel Architekten, Bamberg | Kloster Locom, Hannover | leaderdigital.ch | Markus Otto, Arnsberg | Mattphoto, Hilgert | Max Schulz, Mülheim an der Ruhr | Nick Kane, London | Nicolas Meiringer, Schwetzingen | Norman Radon, Ingolstadt | Olaf Schiefner, Berlin | Piet Niemann, Hamburg | plainpicture / fStop · Ludger Paffrath | Roland Halbe, Stuttgart | Tom Bauer, Würzburg | Zooley Braun, Stuttgart



BEGA